



CTX 3030

The Future of Discovery



Instruction Manual

FBS 2 Smartfind 2  

World's Best Metal Detection Technologies

MINELAB
www.minelab.com

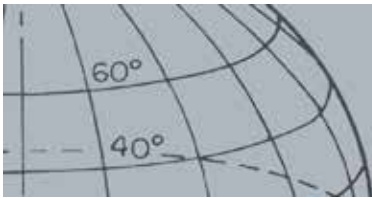

Important safety information

Use of this appliance by children aged less than 8 years of age is prohibited.

This appliance can be used by children aged from 8 years and above and persons with reduced physical, sensory or mental capabilities or lack of experience and knowledge if they are supervised or have been given instruction concerning use of the appliance in a safe way and understand the hazards involved. Children shall not play with the appliance. Cleaning and user maintenance shall not be performed by children without supervision.

COMPLIANCE

Information to the User (FCC Part 15.105) NOTE: Class B Devices

This equipment has been tested and found to comply with the limits for a Class B digital device, pursuant to part 15 of the FCC Rules. These limits are designed to provide reasonable protection against harmful interference in a residential installation.

This equipment generates, uses and can radiate radio frequency energy and, if not installed and used in accordance with the instructions, may cause harmful interference to radio communications. However, there is no guarantee that interference will not occur in a particular installation. If this equipment does cause harmful interference to radio or television reception, which can be determined by turning the equipment of and on, the user is encouraged to try to correct the interference by one or more of the following measures:

- Reorient or relocate the receiving antenna
- Increase the separation between the equipment and receiver
- Connect the equipment into an outlet on a circuit different from that to which the receiver is connected
- Consult the dealer or an experienced radio/TV technician for help

DISCLAIMER

The Minelab metal detector discussed in this instruction manual has been expressly designed and manufactured as a quality hobbyist metal detector and is recommended for use in coin, treasure and general metal detection in nonhazardous environments. This metal detector has not been designed for use as a mine detector or as a live munitions detection tool.

PLEASE NOTE

Since there may be a variety of options available for this detector, equipment may vary according to the Model or items ordered with your detector. Certain descriptions and illustrations may also differ (in this manual) from the exact Model that you purchased. In addition, Minelab reserves the right to respond to ongoing technical progress by introducing changes in design, equipment and technical features at any time.



This work is licensed under the Creative Commons Attribution-NonCommercial-NoDerivatives 4.0 International License. To view a copy of this license, visit

<http://creativecommons.org/licenses/by-nc-nd/4.0/>.

© MINELAB ELECTRONICS PTY LTD.

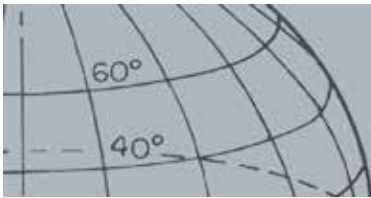
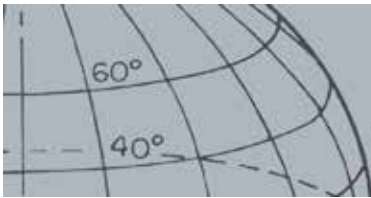
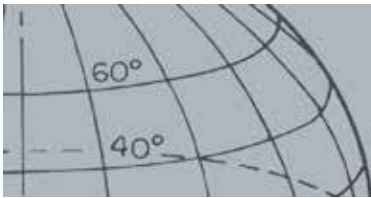

Table of Contents

CTX 3030 Detector	1
Control Panel	2
CTX 3030 Screens	3
<i>Detect Screen</i>	3
<i>Map Screen</i>	4
<i>Menu Screen</i>	4
Status Bar	5
<i>Active Mode Markers</i>	5
<i>Patterns</i>	5
<i>Status Bar Summary</i>	6
Detect Screen	7
<i>Detect Screen Content</i>	7
<i>CTX 3030 Discrimination</i>	8
<i>Accept or Reject a Target</i>	9
<i>Edit Frame Size</i>	9
<i>Target ID Panel</i>	10
<i>Navigation Tool</i>	11
<i>Sensitivity Panel</i>	11
<i>Target Trace</i>	11
<i>Pinpoint</i>	12
<i>Target Trace Pinpoint</i>	12
<i>Using the Detect Button</i>	13
<i>Using the Identify Button</i>	13
Map Screen	14
<i>GPS</i>	14
<i>Map Screen Content</i>	14
<i>Zoom Levels</i>	15
<i>Start Trail</i>	15
<i>Current Position</i>	15
<i>FindPoints and WayPoints</i>	15
<i>GeoTrail</i>	16
<i>GeoHunts</i>	16
<i>North Marker</i>	16
<i>Latitude/Longitude</i>	16
<i>Using the Map Button</i>	17
<i>Clear GeoTrail</i>	17
<i>View GeoTrail</i>	17
<i>Recenter</i>	17
<i>Show Names</i>	17
<i>Using the Store Button</i>	17
<i>Create and Store FindPoints and WayPoints</i>	17
<i>Control a GeoHunt</i>	18
Function Buttons	19



Noise Cancel	19
Open the Noise Cancel Quick Menu	19
Manual Noise Cancel.....	20
Sensitivity	21
Ground Balance.....	21
Open the Ground Balance Quick Menu.....	21
Enable Ground Balance.....	22
Perform Auto Ground Balance	22
Audio.....	22
Open the Audio Quick Menu.....	23
Volume Gain.....	23
Threshold Level.....	23
Volume Limit.....	24
Threshold Pitch.....	24
Menu	24
User Button	25
User Button Functions.....	25
Backlight.....	25
Previous Mode	25
Pinpoint Type.....	25
Target Trace Pinpoint.....	25
Large ID Panel	25
Navigation Tool	25
Sensitivity Panel	26
Coordinate View	26
Target ID Panel.....	26
Assign a Function to the User Button.....	26
Pinpoint	27
Activate Pinpoint.....	27
CTX 3030 Menus	29
Using the Menus	29
Menu Symbols.....	29
Menu Types.....	30
Menu Structure	30
Modes Menu Overview	30
Display Menu Overview.....	31
Options Menu Overview.....	31
Modes Menu	32



Search Modes	32
Open the Modes Menu	32
Select a Mode	32
Delete a Mode	33
Create a New Mode.....	33
Reset a Mode to Default.....	33
Edit a Mode	33
Open the Mode Settings Menu.....	34
Pattern 1 and Pattern 2	34
Open the Edit Type Menu	34
Edit Types	35
Select an Edit Type.....	35
Select Accept All or Reject All.....	35
Tone ID Profile	36
Open the Tone ID Menu	36
Profile Type.....	36
Resize the Tone ID Profile	37
Change Pitch.....	37
Play Tone	38
Play All.....	38
Response.....	38
Normal.....	39
Long.....	39
Smooth.....	39
Pitch Hold.....	39
Change the Response.....	39
Recovery Fast and Recovery Deep.....	39
Recovery Fast.....	39
Turn Recovery Fast On/Off.....	40
Recovery Deep.....	40
Turn Recovery Deep On/Off.....	40
Seawater.....	40
Turn Seawater On/Off.....	41
Target Separation.....	41
Low Trash.....	41
High Trash	41
Ferrous-Coin	42
Ground-Coin	42
Select Target Separation Settings.....	42
Pinpoint.....	42
Normal.....	42
Sizing.....	43
Activate Pinpoint.....	43
Change Pinpoint Type.....	43
GeoStore Menu	44

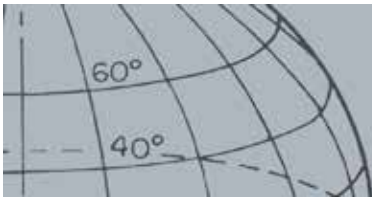

Open the GeoStore Menu.....	44
Sort FindPoints/WayPoints.....	44
Go to a FindPoint or WayPoint.....	44
Go to Start/End of a GeoHunt.....	45
Delete a GeoStore Item.....	45
Display Menu	46
Open the Display Menu	46
Show or Hide Detect Screen Items.....	46
Show or Hide Map Screen Items.....	47
Options Menu	48
Open the Options Menu	48
Wireless Settings.....	48
GPS Settings.....	48
Enable.....	48
Location Format	49
GPS Time Sync	49
Locality Settings.....	49
Set Time.....	49
Time Zone	49
Time Format.....	49
Units.....	49
Backlight Settings	49
Brightness.....	49
Backlight.....	49
Pinpoint Lock.....	50
Reset the CTX 3030	51
Open the Reset Quick Menu.....	51
Reset GeoStore	51
Reset Settings.....	51
Language.....	52
Reset the Language.....	52
Wireless Audio Module	53
Connect the WM 10.....	53
Minelab XChange 2	54
Communicating between CTX 3030 and your PC.....	54
System Requirements	54
Install CTX 3030 XChange 2 on your PC.....	54
Start the CTX 3030 XChange 2 Application	54
Connect CTX 3030 to your PC.....	54
Factory Presets	55
Modes	55

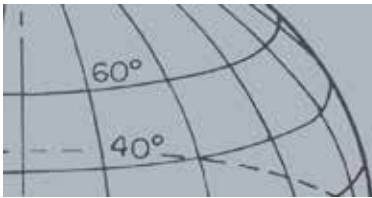

<i>Audio</i>	55
<i>Other Settings</i>	55
Batteries	56
<i>BC 10 Battery Charger</i>	56
<i>Recharge the Lithium-Ion Battery Pack</i>	57
<i>Replace the 'AA' Batteries</i>	58
Accessories	60
Detector Care and Safety	61
GPS and Navigation	62
<i>GPS</i>	62
<i>Map</i>	62
<i>Navigation</i>	62
Detecting Basics	63
<i>Holding the Detector</i>	63
<i>Adjust the Length of the Shafts</i>	63
<i>Adjust the Angle of the Coil</i>	63
<i>Sweeping the Coil</i>	63
<i>Detector Sounds</i>	65
Simple Detecting Exercise	66
Technical Specifications	67
<i>CTX 3030</i>	67
<i>Battery and Charger BC 10</i>	67

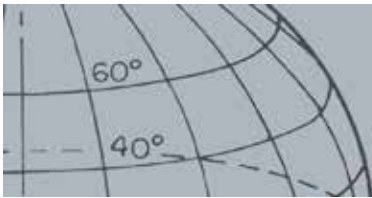

CTX 3030 Detector

CTX 3030 Detector

For instructions on how to assemble your CTX 3030 refer to the Getting Started Guide supplied with the detector.

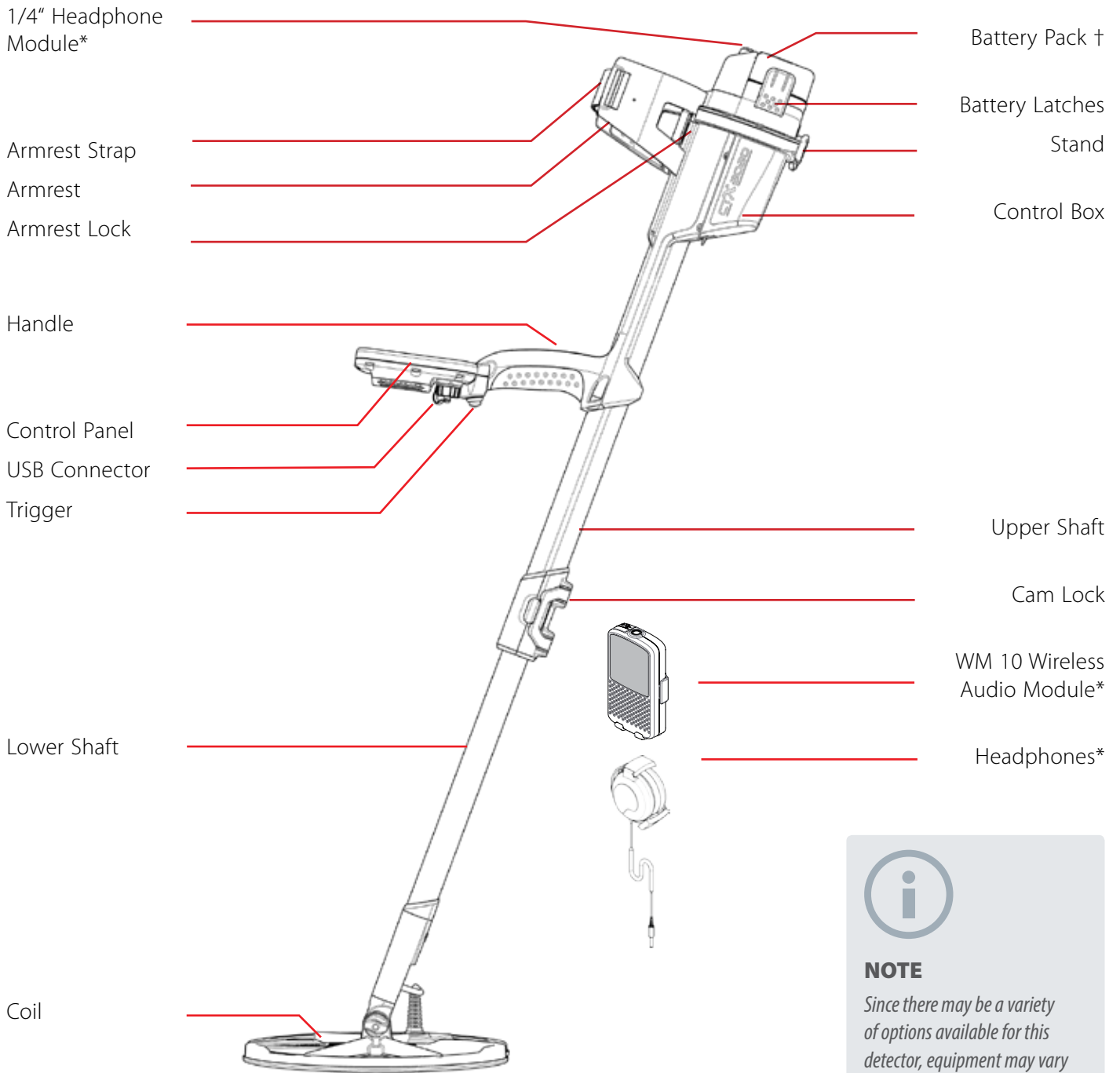

* Not waterproof
† Waterproof only when attached



NOTE

Since there may be a variety of options available for this detector, equipment may vary according to the model or items ordered. Certain descriptions and illustrations may also differ (in this manual) from the exact model you purchased.

Control Panel



Rear Speaker

USB Connection

Trigger

Trigger

Press from the Detect/Map screens to activate the Pinpoint function.

Press from menu screens to cancel the current action and move back one level.

Control Panel

The control panel consists of the following:

- Full color LCD screen
- Push button keypad with 11 buttons
- Handle mounted trigger
- USB connection
- Rear speaker



Power Button

Press to turn the CTX 3030 On/Off
Press and hold from Off to reset the detector (page 51)

User Button

Press to activate your selected function (default Backlight) (page 24)
Press and hold to view the User Quick Menu (page 24)

Detect Screen Control Buttons

Detect

Press to view the Detect screen (page 7) and toggle between Discrimination Patterns (page 9)
Press and hold to control Detect screen items (page 46)

Map Screen Control Buttons

Map

Press to view the Map screen (page 14) and cycle between zoom levels (page 15)
Press and hold to control Map screen items (page 47)

Identify

Press while detecting to accept or reject a target area (page 9)
Press and hold to change the Edit Frame size (page 9)

Store

Press to store a WayPoint or FindPoint (page 17)
Press and hold to view GeoHunt menu (page 18)

Function Buttons

Noise Cancel/Up Arrow

Press and hold to view the Noise Cancel Quick Menu (page 19)
Press from the Detect/Map screens to perform Noise Cancel (page 20)
Press from the menu screens to move upwards

Menu/Select

Menu - Press from the Detect/Map screens to access the top-level menu (page 29), or press from within the menus to access the last used menu adjustment.
Select - Press from within the menu screens to select a menu option

Ground Balance/Down Arrow

Press and hold to view the Ground Balance Quick Menu (page 21)
Press from Detect/Map screens to perform Ground Balance (page 21)
Press from menu screens to move downwards

Sensitivity/Left Arrow

Press and hold to view the Sensitivity Quick Menu (page 21)
Press from the Detect/Map screens to view the last adjusted sensitivity setting
Press from the menu screens to move left

Audio/Right Arrow

Press and hold to display the Audio Quick Menu (page 22)
Press from the Detect/Map screens to view the last adjusted audio setting
Press from the menu screens move right

CTX 3030 Screens

The CTX 3030 graphical user interface (GUI) has three main screens:

1. Detect screen – where your detector status and detection results are displayed
2. Map screen – where location GPS functionality is displayed
3. Menu screen – where you can access all the detector settings menus

Each screen can be directly accessed from any other screen by pressing the appropriate control button.

A Status Bar is displayed at the top of the Detect and Map screens to provide status information for various detector functions and settings. For further information on the Status Bar, see page 5.

Access the Detect screen at any time by pressing the Detect button.



Detect

Detect Screen

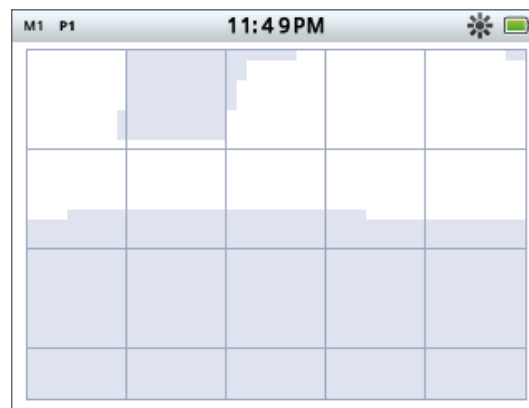

Figure 1 – Default Detect screen

Use the Detect screen to:

1. View and interpret detection results (Target ID, Depth, Target Cursor, Target Trace, Pinpoint)
2. View and edit the Discrimination Patterns
3. View the status of the detector

For further information on the Detect screen, see page 7.

CTX 3030 Screens

Access the Map screen at any time by pressing the Map button.



Map

Map Screen

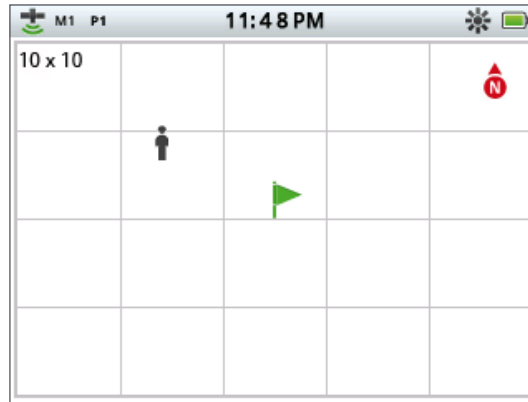

Figure 2 – Example Map screen

Use the Map Screen to:

1. View your current location and GPS coordinates
2. View your GeoTrail, WayPoints, FindPoints and GeoHunts
3. Navigate to a location
4. View the status of the detector

For further information on the Map screen, see page 14.

Access the Menu screen at any time by pressing the Menu button.



Menu

Menu Screen

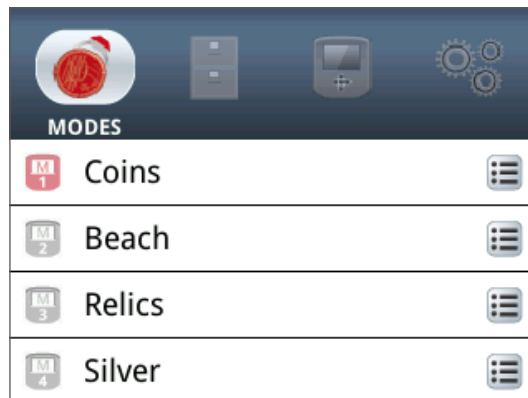

Figure 3 – Main Menu screen

Use the Main Menu screen to access all detector settings menus. The detector settings are grouped into four categories:

1. Modes – display and edit the settings of the current search mode; select up to ten search modes
2. GeoStore – store finds and data in the detector
3. Display – control your view of the Detect and Map screens
4. Options – adjust detector settings options

For further information on the CTX 3030 menus, see page 29.

Status Bar

Status Bar

The Status Bar is displayed at the top of the Detect and Map screens and provides status information for the following functions:

- Headphones
- Wireless
- GPS
- Current Search Mode
- Current Pattern
- Time
- GeoHunt
- Backlight
- Battery

Each function is represented by an icon (*Figure 4*). The icon can vary or may disappear as the state of each function changes. For further details on the status bar icons and their various states refer to the summary table (*Table 5*).

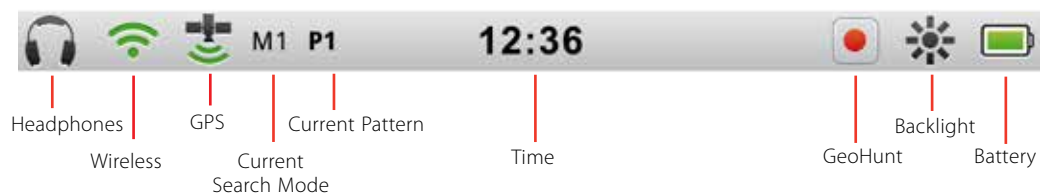

Figure 4 – Status Bar content

Active Mode Markers

An Active Mode Marker will appear in the status bar to indicate which search mode is currently active. Mode numbers are assigned to each of the modes in order (*M1 to M10*). For more information on search modes, see page 32.

Patterns

The pattern marker will appear in the status bar to indicate which discrimination pattern is currently active. Each pattern has been assigned a unique marker as follows:

- P1 – Pattern 1
- P2 – Pattern 2

Status Bar

Status Bar Summary















Headphones	Not Connected		Detector Headphones Connected		WM 10 Headphones Connected	
	No icon					
Wireless	Off		On, Not Connected		On and Connected	
	No icon		 (flashing)			
GPS	Off		On, No Fix		On and Fixed	
	No icon		 (flashing)			
Mode	Current Search Mode – numbered 1 to 10					
	M1					
Pattern	Pattern 1		Pattern 2			
	P1		P2			
Time	12 Hour		24 Hour			
	1:42 PM		13:42			
GeoHunt	Off		Record		Pause	
	No Icon					
Backlight	Off		On			
	No Icon					
Battery	100%	80%	60%	40%	20%	Empty
						

Table 5 – Summary of Status Bar icons

Detect Screen



Detect



Identify

The Detect screen is used in conjunction with the Detect and Identify control buttons.

Detect Screen

The Detect screen is the first screen you will see when you turn the detector on, and where you will spend the majority of your time. This screen graphically displays the discrimination patterns and target information.

At the top of the Detect screen is the Status Bar, which displays information about the current detector settings (page 5).

The Detect screen can be accessed at any time by pressing the Detect button.

Detect Screen Content

The content of the Detect screen will vary according to its current state and your actions. This screen can display the following content:

- Discrimination Patterns
- Target Cursors (*accepted and/or rejected*)
- Target ID Panel (*FE-CO numbers and depth - see page 10*)
- Target Trace
- Pinpoint Gauge

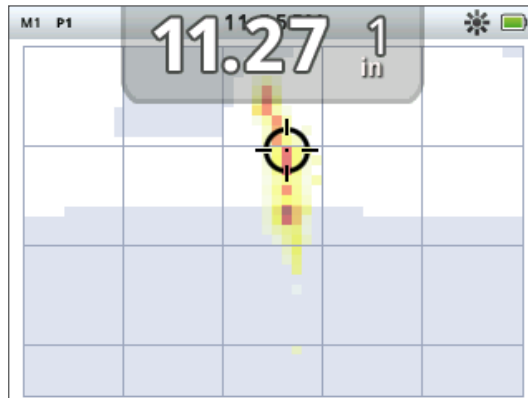

Figure 6 – Detect screen content



Figure 7 – Detect screen showing optional elements

The following screen elements are optional and can be controlled through the Display menu:

- Large Target ID Panel
- Navigation Tool
- Sensitivity Panel

For information on how to show and hide optional screen elements, see page 46.

Detect Screen

CTX 3030 Discrimination

Discrimination is the detector's ability to identify and classify signals from metallic materials, then mask signals from undesired trash and highlight signals from desirable targets. The CTX 3030's advanced signal processing simultaneously analyses objects according to their conductive (CO) and ferrous (FE) properties. The different FE-CO properties can be displayed numerically and graphically on the Detect screen as well as being heard as distinctive audio tones based on these properties. The CTX 3030 utilizes Minelab's unique scale of discrimination, which numerically represents a target's ferrous and conductive properties on the same display (Figure 8).

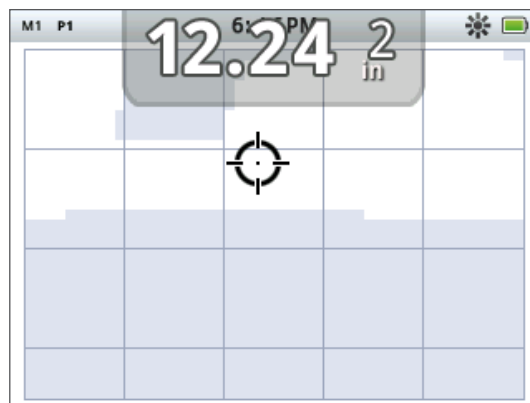

Figure 8 – Detect screen showing discrimination scale

The horizontal axis rates the target on its size/conductivity (CO), ranging from 1 to 50, left to right. A CO value of 1 represents low conductivity (*small alloy coins, foil, 9 ct and fine jewelry*) and 50 represents high conductivity (*large silver coins, copper items*).

The vertical axis rates the extent of the target's ferrous characteristics (FE), ranging from 1 to 35, top to bottom. An FE value of 1 represents low ferrous characteristics and a value of 35 represents high ferrous characteristics.

As the coil passes over a target, the detector digitally processes the target signals. At the end of detection the Detect screen will display a Target Cursor and a Target ID Panel showing the target's FE and CO properties. The position of the cursor is relative to these properties.

The Discrimination pattern is shown on the Detect screen as white and shaded regions of the discrimination area. White regions indicate accepted areas where targets of interest will produce Target IDs and detector audio. Shaded regions indicate rejected trash areas where targets will be ignored and do not produce audio and Target IDs.

When an accepted target is detected, the Accept cursor will appear in the white area and a target response will be heard. The Target ID Panel will be displayed at the top of the screen.

When a rejected target is detected the Threshold will blank and the Reject cursor will appear.

Ferrous targets (*e.g. nails*) contain a large amount of iron, or some magnetic material. Because they are magnetic, ferrous targets generally display the Target cursor at the bottom of the Detect screen.

Target Cursors



Accept Cursor



Reject Cursor

Detect Screen



NOTE

In reality, most non-ferrous targets will display some ferrous properties resulting in FE values higher than 1.

Non-ferrous targets (e.g. pure gold, silver, copper and bronze) contain little or no magnetic material. Because they are not magnetic, nonferrous targets will generally display the Target cursor at the top of the Detect screen.

High conductive targets (e.g. large silver coins, copper items) will cause the Target cursor to appear toward the right of the Detect screen.

Low conductive targets (e.g. small alloy coins, foil, 9 ct and fine jewelry) will cause the Target Cursor to appear toward the left of the Detect screen.

The object size will have some effect upon the conductivity rating for targets; generally, the larger the target, the higher the corresponding conductivity rating.

The CTX 3030 offers two Detect Discrimination Patterns, for each of the ten search modes, Pattern 1 (P1) and Pattern 2 (P2). Each time you press the Detect button from the Detect screen the detector will toggle between the two available patterns. This will be reflected in the Status Bar.

Cycle between Discrimination Patterns

Each time you press the Detect button the detector will toggle between the two available patterns, Pattern 1 and Pattern 2.

Accept or Reject a Target

The Discrimination Pattern can be modified at any time while detecting in the Detect screen. An undesirable target can be masked or a desirable target can be unmasked.

1. When the target is detected, and while the FE-CO numbers are displayed, press the Identify control button.
 - The first press will turn the pattern white (*accepted*) in that region
 - The second press will turn the pattern grey (*rejected*) in that region
 - The third press will return that region to its original, unaltered state



NOTE

Press and hold the Identify button to allow the size of the region being altered to be changed.

Edit Frame Size

Target ID accuracy can be affected by other targets or ground minerals so sometimes you will need a precise pattern. At other times you will need a more open pattern to ensure you don't miss a desired target.

The frame used to edit the patterns can be configured to four different sizes ranging from small to large. A large Edit Frame will modify a larger area of the pattern, and a small frame will modify a smaller area.

To change the Edit Frame size:

1. Press and hold the Identify control button to display the Identify Quick Menu. The following options are available:
 - 1 x 1
 - 2 x 2
 - 3 x 3 (*default*)
 - 5 x 5



Edit Frame



Edit Frame 1 x 1



Edit Frame 2 x 2



Edit Frame 3 x 3



Edit Frame 5 x 5

Detect Screen

Use the down arrow button to highlight your preferred Edit Frame size and press Select. You will be returned to the Detect screen and the Edit Frame size will be reset.

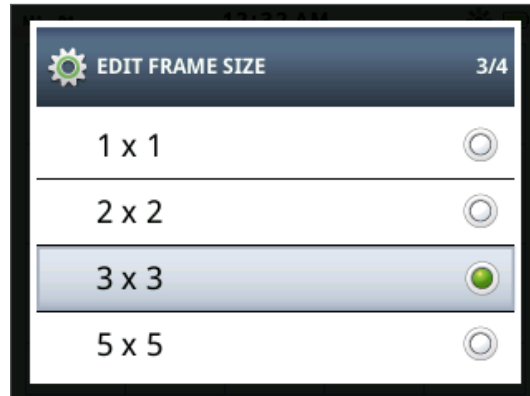

Figure 9 – Identify Quick Menu

Target ID Panel

When an object is detected the Target ID panel will appear at the top of the screen showing the following information:

- Ferrous property – a number from 1 to 35
- Conductive property – a number from 1 to 50
- Target depth – inches or centimeters



Figure 10 – Detect screen showing Target ID Panel

Information is refreshed at the end of a detection event enabling fast, clear and reliable interpretation of a potential target's properties. With practice and experience you will be better able to interpret the information displayed, leading to more successful detecting.

A large format Target ID panel can be optionally displayed through the Display menu (page 46).

Detect Screen

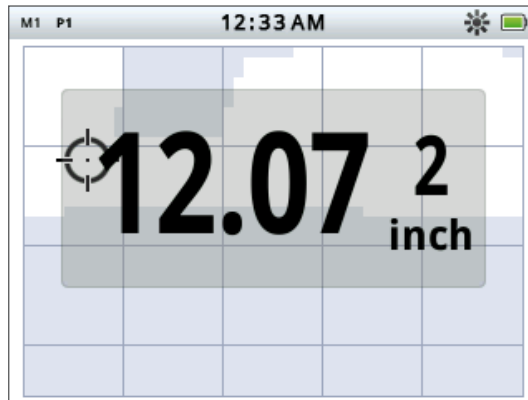
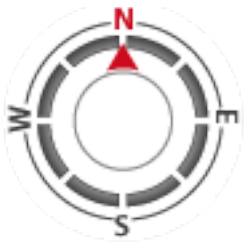

Figure 11 – Detect screen showing large Target ID panel



Navigation Tool



Sensitivity Panel

Navigation Tool

The Navigation Tool is optionally displayed (*page 46*) in the bottom left hand corner of the Detect screen and, when enabled, allows you to navigate to a WayPoint, FindPoint or the start or end point of a GeoHunt.

The Navigation Tool displays a compass dial with direction markers for North (N), South (S), West (W) and East (E). Your bearing to the destination is indicated by the position of the red arrow, and your distance from the destination is displayed in the center of the tool in feet/miles or meters.

Sensitivity Panel

The Sensitivity Panel is optionally displayed at the bottom center of the screen and shows your sensitivity settings as follows:

- Current sensitivity mode (Manual or Auto)
- Current level of sensitivity (Range 1 to 30)
- Suggested level of sensitivity (Range 1 to 30 - manual only)

Sensitivity settings are adjusted through the Sensitivity Quick Menu. For further information, see *page 21*.

Target Trace

Target Trace shows a real time animation of the many detections per second that the detector uses to determine a Target's ID. This is particularly useful when targets are detected in close proximity, or in cluttered environments. In these instances, the Target Trace display can be used to help identify individual targets.

Target Trace can be optionally displayed over the discrimination pattern, and shows the FE-CO readings that are being produced during a detection. Color coding signifies signal strength.

Detect Screen

Press and hold the Detect button to open the Detect Screen Quick Menu and enable Target Trace.

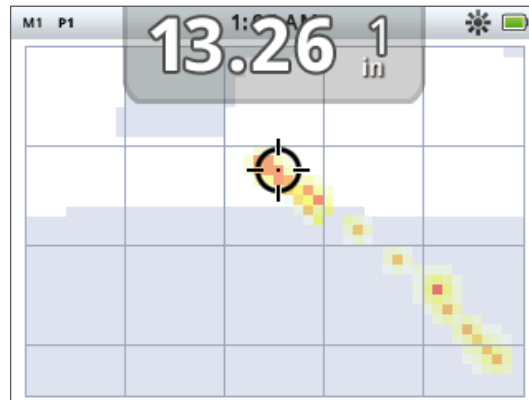

Figure 12 – Target Trace showing two targets (coin and nail)

Pinpoint

The Pinpoint Gauge is optionally displayed at the bottom of the Detect screen (Figure 13) and graphically indicates the strength of the signal received during Pinpointing.

To display the Pinpoint Gauge, simply press and hold the trigger.



Figure 13 – Detect screen with Pinpoint activated

For more information on Pinpoint, see page 27.

Target Trace Pinpoint

Press and hold the Detect button to open the Detect Screen Quick Menu and enable Target Trace Pinpoint.

When enabled during pinpointing, the Target Trace display differs slightly from normal. The display shows the same Target Trace but the information stays on the screen. This allows difficult targets to be carefully examined, using multiple sweeps to build up a stronger Target Trace image, until the trigger is released.



Detect Screen



Detect

Using the Detect Button

Use the Detect button from any screen to access the Detect screen and view the Discrimination Patterns, and access the Detect menu.

Press the Detect button to cycle between the two discrimination patterns (see page 9).

Press and hold the Detect button to display the Detect Quick Menu. The available options are:

- Target Trace
- Target Trace Pinpoint

Use the arrow buttons to highlight your required option/s and press Select.



Identify

Using the Identify Button

Use the Identify button to accept or reject a target (page 9) and to change the size of the Edit Frame (page 9).

Map Screen



Map



Store

The map screen is used in conjunction with the Map and Store control buttons.



GPS Status Bar Icon



NOTE

If there is no WayPoint, FindPoint or GeoHunt near the current location, the Map screen may be blank.

Map Screen

The Map screen displays FindPoints, WayPoints, GeoHunts and GeoTrails in their relative geographic locations. It represents a default map dimension of 100 yards (or meters) in the east-west horizontal direction and 80 yards (or meters) in the north-south vertical direction. Three zoom levels are available for viewing the map screen:

- 10 x 10 yards/meters per cell
- 20 x 20 yards/meters per cell (default)
- 100 x 100 yards/meters per cell

The map displays north-south and east-west grid lines, centered on your current location. The distance between the grid lines will depend on your current zoom level (page 15). The upper horizontal edge of the screen display will represent north irrespective of the detector orientation.

At the top of the Map screen is the Status Bar, which displays information about the current detector settings (page 5).

The Map screen can be displayed at any time by pressing the Map button.

GPS

The location and navigational elements of the Map screen work in conjunction with the Global Positioning System (GPS). By default the GPS receiver is turned off and must be turned on through the Options menu (page 48). Once GPS is turned on a flashing GPS icon will appear on the Status Bar. When an absolute position fix has been established (which may take several minutes), the GPS icon on the Status Bar will stop flashing and remain static.

On entering the Map screen a marker will be displayed at the centre of the screen to represent your initial start location. If there is a valid GPS position fix, movement will be displayed on the map as a series of dots that form a GeoTrail.

Map Screen Content

The content of the Map Screen will vary according to its current state and your user preferences. The Map screen can display the following elements:



- Zoom Level
- Start Trail
- Current Position
- FindPoints and WayPoints
- GeoTrail
- GeoHunt
- North Marker
- Latitude and Longitude

Figure 14 – Map screen showing all content elements

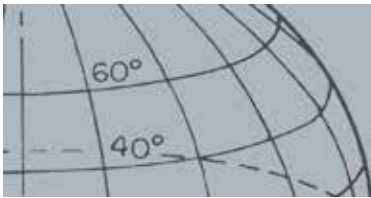

Map Screen

The following screen elements are optional and can be controlled through the Display menu:

- Target ID Panel (*page 10*)
- Sensitivity Panel (*page 11*)
- Navigation Tool (*page 11*)
- Names of GeoStore items (FindPoints, WayPoints)

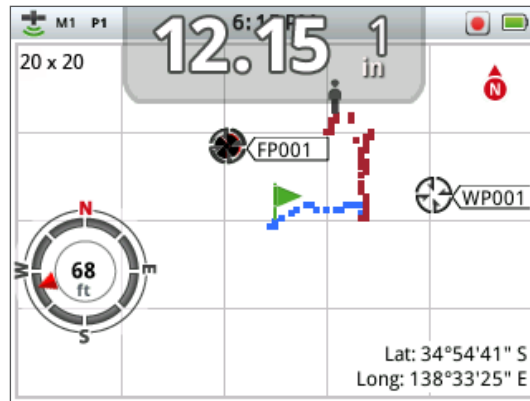

Figure 15 – Map screen showing optional elements

For information on how to show and hide optional screen elements, see page 47.

Zoom Levels

The zoom level indicator is displayed at the top left of the Map screen. It indicates the current size of the grid square in yards or meters (10 x 10, 20 x 20 or 100 x 100).

The detector will cycle through the three available zoom levels each time you press the Map button.



Start Trail



Current Position

Start Trail

On entering the map screen a marker will be displayed at the centre of the screen to represent your initial start location.

Current Position

The current position marker displays your location on the Map Screen.



FindPoint

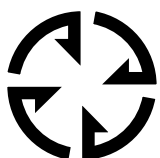

WayPoint

FindPoints and WayPoints

FindPoints and WayPoints are displayed on the Map Screen to indicate find locations and points of interest. They will be displayed at a consistent size regardless of the zoom level, but those in close proximity will be overlapped. By default FindPoints and WayPoints are displayed with their names, but if space is limited the names can be hidden (*page 17*).

FindPoint

A FindPoint stores the location and details of a target. When you choose to store a FindPoint (*page 17*), the CTX 3030 stores the following information:

- Location (Latitude/Longitude)
- Time and date
- Search mode settings (Target ID, depth,)

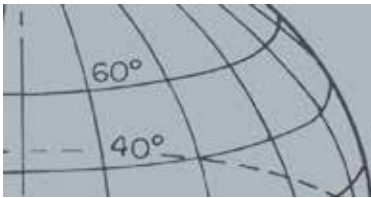

Map Screen



NOTE

Target ID's must be active (on the screen) to be saved as part of a FindPoint.

Your FindPoint information can be used for future reference within the detector and with the XChange 2 PC application (page 54).

WayPoint

A WayPoint is similar to a FindPoint with the exception that no detector related information is stored. The WayPoint is used to record a point of interest or location to which you may choose to return in the future. When you choose to store a WayPoint the CTX 3030 stores the following information:

- Location
- Time and date

You can also create a WayPoint as a navigation point on Google Maps using the XChange 2 PC application (page 54).

GeoTrail

GeoTrail position information is recorded every second and can be represented on the screen by a series of dots that form a trail. If a GeoTrail is being recorded as part of a GeoHunt, the trail will be maroon, otherwise it will be blue.

GeoHunts

When the GeoHunt function is active, the CTX 3030 stores your position information while you are detecting. It allows you to see a map view of the ground you have covered, and records the location, time and detector settings used. FindPoints and WayPoints stored while a GeoHunt is active are displayed and stored with the GeoHunt.

When you activate the GeoHunt function, the CTX 3030 stores the following information:

- Periodic location (GeoTrail)
- Time
- Detector settings
- FindPoints and WayPoints

You can upload your GeoHunts to your PC and view them on Google maps using the XChange 2 application (page 54).



North Marker

North Marker

The North Marker is displayed at the top right of the screen. It indicates a northerly direction in relation to the detecting trail.

Latitude/Longitude

Latitude/Longitude information for the target is optionally displayed at the bottom right of the screen. The format of the display can be configured in the Options menu (page 48).

Lat: __. __ deg.
Long: __. __ deg.

Latitude/Longitude display

Map Screen



Map

Using the Map Button

Use the map button from any screen view the Map screen, cycle between zoom levels and access the Map Quick Menu.

Press the Map button to cycle between zoom levels.

Press and hold the Map button to display the map menu and initiate the following actions:

- Clear GeoTrail
- View GeoTrail
- Recenter
- Show Names

Clear GeoTrail

The Clear GeoTrail option will remove the current GeoTrail from the map screen.

View GeoTrail

The View GeoTrail option will display the current GeoTrail on the map screen.

Recenter

The Recenter option will place your current position at the center of the map screen.

Show Names

The Show Names option will show or hide the names of all FindPoints and WayPoints displayed on the map screen. By default the Show Names option is on, but names can be hidden to save space when many items are displayed on the screen at once.



Store

Using the Store Button

Use the Store button to store FindPoints and WayPoints, and control a GeoHunt:

1. Press the Store button to create and store FindPoints and WayPoints
2. Press and hold the Store button to control a GeoHunt

Create and Store FindPoints and WayPoints

1. Press the Store button to display the FindPoint/WayPoint menu. The available options are:
 - Create FindPoint
 - Create WayPoint
2. Use the arrow buttons to highlight Create FindPoint or Create WayPoint and press Select to display the following:
 - Name of item
 - Option to Save
 - FE-CO coordinates of item
 - Lat-Long coordinates of item



NOTE

A valid GPS position fix is required to use the Store button functions.

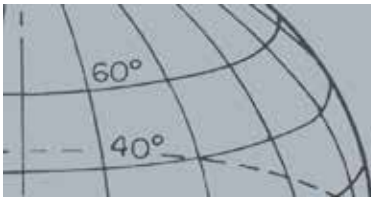

Map Screen

3. Press the Select button to Save.

A confirmation message will be displayed providing the name of the saved item. After a few seconds the message will disappear and you will be returned to the Map screen.

Control a GeoHunt

To record a GeoHunt:

1. Press and hold the Store button to display the GeoHunt menu. The available options are:
 - Record
 - Stop
 - Pause
2. Use the down arrow button to highlight the Record option and press Select.

The detector will record your detecting activities until you pause or stop the GeoHunt. The Record GeoHunt icon will appear in the Status Bar and your movements will be displayed on the Map screen as a maroon GeoTrail.

To pause a GeoHunt:

1. Press and hold the Store button to display the GeoHunt menu.
2. Use the arrow buttons to highlight the Pause option and press Select.

The CTX 3030 will temporarily cease recording your detecting activities and the Pause GeoHunt icon will appear in the Status Bar.

To stop a GeoHunt:

1. Press and hold the Store button to display the GeoHunt menu.
2. Use the arrow buttons to highlight the Stop option and press Select.

The CTX 3030 will cease recording your detecting activities and the Stop GeoHunt icon will appear in the Status Bar. The stored GeoHunt can be transferred to the XChange 2 PC application for display, editing and storage, or to help plan your next hunt.

Loss of Power during a GeoHunt

In the event of the detector powering down or being plugged into a PC while you are recording or have paused a GeoHunt, the GeoHunt will stop and the logging of data will cease.

Loss of GPS Position Fix during a GeoHunt

In the event of a GPS position fix not being available the GeoTrail location dots will not be displayed and the logging of data will cease temporarily (*it will continue automatically once a position fix becomes available*).

If the detector's internal memory becomes full, the CTX 3030 will stop recording and an alert message will be displayed.

GeoHunt Status Icons



Record GeoHunt



Pause GeoHunt



Stop GeoHunt

Function Buttons

Function Buttons

The CTX 3030 Control Panel has five function buttons as follows:

- Noise Cancel
- Sensitivity
- Ground Balance
- Audio
- Menu/Select

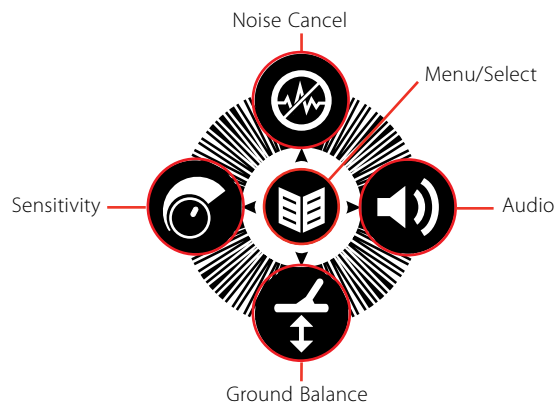

Figure 16 – CTX 3030 function buttons

Each function button performs three actions depending on which screen is currently active, and whether you 'press' or 'press and hold' the button.

1. Press and hold to open the function Quick Menu.
2. Press from the Map or Detect screens to return to the last used function.
3. Press from the menu screens to move around the screen or adjust settings.

Noise Cancel

The Noise Cancel function allows you to eliminate electromagnetic interference (EMI) or noise from the detector.

The CTX 3030 may become noisy due to electrical interference from power lines, electrical equipment or other detectors operating close by. The detector interprets this interference as inconsistent, erratic detections. Noise Cancel can be performed automatically (*default*) or manually.

Auto Noise Cancel instructs the detector to automatically scan and listen to every channel, and select the one with least interference.

Open the Noise Cancel Quick Menu

1. Press and hold the Noise Cancel button to display the Noise Cancel Quick Menu. The available options are:
 - Auto (*default*)
 - Manual



Noise Cancel

- › Press from Detect or Map to perform Noise Cancel
- › Press and hold at any time to display the Noise Cancel Quick Menu
- › Press from the menus to activate the UP arrow

Function Buttons

Perform Auto Noise Cancel

Auto Noise Cancel is recommended.

1. Make sure there are no large targets or obvious sources of EMI close by, and hold the detector coil 12 inches (30 centimeters) above the ground (Figure 17).
2. From the Map or Detect screens press the Noise Cancel button to initiate Auto Noise Cancel.

Automatic channel selection will commence and a progress bar will be displayed. Keep the detector still during the selection process, which may take up to 30 seconds. Press the trigger to terminate Noise Cancel at any time.

When the progress bar reaches 100% it will disappear and an audio signal will convey that Noise Cancel is complete.



Figure 17 – Correct detector position for Noise Cancel

Manual Noise Cancel

The Manual setting allows you to manually select and listen to each channel for the least interference.

To manually adjust Noise Cancel:

1. Make sure there are no large targets or obvious sources of EMI close by, then hold the detector 12 inches (30 centimeters) above the ground (Figure 17).
2. Open the Noise Cancel Quick Menu and use the down arrow button to highlight the Manual option. Press Select.
3. Press the left or right arrow buttons to select a channel. Pause and listen to the interference coming from the detector. Keep the detector still during this process.
4. Once the channel with the least interference has been found, press the Select button to save and exit the menu.

Function Buttons



Sensitivity

- › Press from the Detect or Map screens to adjust the Sensitivity setting
- › Press and hold at any time to display the Sensitivity Quick Menu
- › Press from the menu screens to activate the LEFT arrow



NOTES

In Auto Sensitivity the detector is able to operate at a higher sensitivity level than you are able to achieve for the same noise level.

Most Beaches are non-mineralized, therefore greater depth can be achieved using the highest stable Manual Sensitivity.



Ground Balance

- › Press from the Detect or Map screens to return to the last used GB function
- › Press and hold at any time to display the Ground Balance Quick Menu
- › Press from the menu screens to activate the DOWN arrow

Sensitivity

Sensitivity controls the detector's response to received signals. These signals can include desirable signals from nearby metal, as well as undesirable signals from electronic noise, and noise due to ground response. Increasing the sensitivity level may make targets more detectable but may also increase detector noise due to these noise influences.

When set to Auto Sensitivity, the detector continuously measures the response from magnetic ground and sets the sensitivity level in order to minimise the effects of these ground signals. If there is no magnetic ground (non-mineralized ground), e.g. on most beaches, AutoSensitivity has nothing to measure and can therefore be unreliable. In these conditions Manual Sensitivity should be used. When set to Manual Sensitivity, you can adjust the sensitivity setting to your desired level.



The Sensitivity Panel can optionally be displayed on the Detect Screen.

The green number on the right of the panel shows the suggested sensitivity level. If you select Manual

Sensitivity, this is the sensitivity level that the detector would suggest using, given the current conditions.

The large number on the left of the panel displays the current sensitivity level. In Manual Sensitivity, this is the level that you have set, and in Automatic Sensitivity this is the internal value that the detector is currently using.

Adjust Sensitivity Settings

1. Press and hold the Sensitivity button to display the Sensitivity Quick Menu. Choose from the following options:
 - Sensitivity (Auto/Man)
 - Auto Level (Range -3 to +3)
 - Manual Level (Range 1-30)
2. Use the arrow buttons to highlight the required setting and press Select.

Ground Balance

Ground Balance (GB) allows you to easily adjust the detector to suit detecting in highly mineralized ground. In these conditions, correctly adjusted Ground Balance will help to find deeper targets that might be hidden by ground noise, as well as helping to stabilize target IDs. Ground Balance is best used in conjunction with Coin-Ground Target Separation.

Ground Balance should not be enabled in most detecting conditions where ground mineralization is mild. This includes most beaches, parks and sports grounds.

Open the Ground Balance Quick Menu

Press and hold the Ground Balance button from the Detect or Map screens to open the Ground Balance Quick Menu. The available options are:

- Enable GB
- Start GB

Function Buttons



NOTES

DO NOT Ground Balance at the beach – leave GB disabled.

In highly mineralized ground it may be necessary to repeat the Ground Balance process.

If you are unable to successfully Ground Balance, disable GB before continuing.

Enable Ground Balance

The Enable GB option toggles between on or off as indicated by the green tick in the check box to the right of the option. By default, the Enable GB option is selected when the menu opens, and the check box is empty indicating that Ground Balance is off.

1. Press Select to confirm Enable GB selection.
A green tick will appear in the check box and Ground Balance is enabled.
2. Press Select again to remove the green tick and disable Ground Balance.

Perform Auto Ground Balance

Ground Balance must be enabled to perform Auto Ground Balance.

1. Find a metal free location near the area being detected. This may not be easy in a cluttered environment.
2. With the Ground Balance Quick Menu displayed, use the down arrow button to highlight the Start GB option and press Select.

A message will be displayed to confirm Ground Balance in progress.

3. Lift the coil to approximately 1 foot (30 cm) above the ground, then lower it again until it almost touches the ground. Repeat this movement several times.

Audio will provide feedback during the GB process. The audio should quickly get quieter and upon successful completion will be totally quiet.

A second message will advise you when the GB process is complete.

4. If a complete Ground Balance is not achieved, repeat steps 2 and 3.

Audio

Audio settings for the detector's internal speaker, headphones, wireless speaker and wireless headphones are independently adjustable via the Audio menu. The audio option used will be dictated by the current detector settings as shown in Table 18.

Audio Output	Detector Settings and Connections
WM 10 Headphones	Wireless enabled and connected + headphones connected
WM 10 Speaker	Wireless enabled and connected + headphones not connected.
Detector Headphones	Wireless not enabled + headphones connected.
Detector Speaker	Wireless not enabled + headphones not connected

Table 18 – CTX 3030 audio options

The Audio function button gives you access to all Audio settings.



Audio

- › Press from the Detect or Map screens to display the last adjusted Audio setting
- › Press and hold at any time to display the Audio Quick Menu
- › Press from the menu screens to activate the RIGHT arrow

Function Buttons

Open the Audio Quick Menu

Press and hold the Audio button at any time to display the Audio Quick Menu and adjust your audio settings. The menu options are:

- Volume Gain
- Threshold Level
- Volume Limit
- Threshold Pitch

For Threshold Level and Volume Limit, the currently used audio output will be adjusted.

Volume Gain

Range: 1–30

Factory Preset: 24

Volume Gain controls the amplification of a target's audio response, relative to the target signal strength. This audio setting is most similar to volume adjustments in other devices (*e.g. radio or television volume controls*).

With a setting of 1 the target signal will not be amplified. Weak target signals will sound quiet, medium target signals will sound mid-range and strong target signals will sound loud. There will be greater differentiation between target signal strengths; however, weak signals will be harder to hear.

With a setting of 30, all target signals will be amplified to a loud audio response. At this setting there will be less differentiation between medium and strong signals, but weak target signals will be easier to hear.

Threshold Level

Range: 1–30

Factory Preset: 30

The constant background 'hum' produced by the detector is called the Threshold. Variations in the Threshold help you to hear very small and deep targets. When a rejected target is detected, the Threshold sound will 'blank' (*become silent*) indicating that an undesired target is underneath the coil.

The Threshold is controlled by Threshold Level and Threshold Pitch. The correct adjustment of both Threshold settings will depend on your hearing and environmental noise such as wind, waves and machinery.

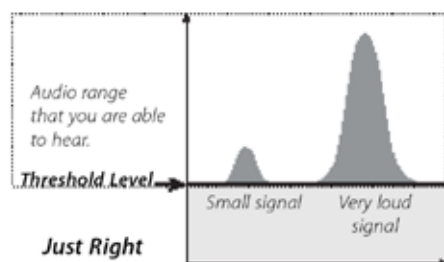

Adjust the Threshold Level to a faint, audible hum. This will highlight variations in signal response which may indicate the presence of a target. If the soil conditions change the Threshold Level may need adjustment.

Function Buttons



NOTE

A high Volume Limit will allow a greater difference between a small and large target.

A low Volume Limit will reduce the volume difference between small and large targets.

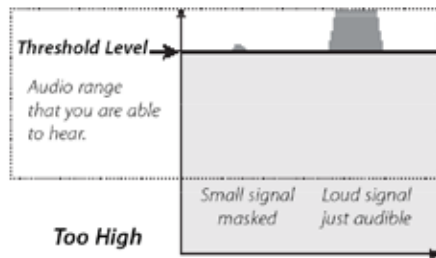

If the Threshold Level is too high, faint targets will be harder to hear above the Threshold 'hum'.

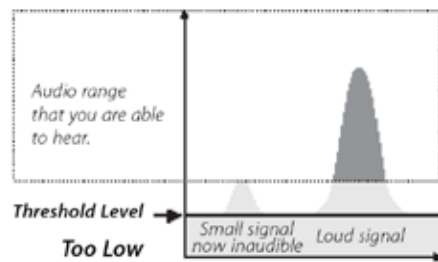

If the Threshold Level is too low, the slight variation caused by a small or deep target may not be sufficient to hear. Adjusting the level to below an audible level will ensure silent operation but could mask the audio response from small or deep targets.

Figure 19 – Threshold Levels

Volume Limit

Range: 0–30

Factory Preset: 30 (detector speaker)

The Volume Limit sets the maximum volume for target signals. When detecting, the sound produced by a target can be very loud. Adjust the Volume Limit to ensure that loud targets do not hurt your ears.

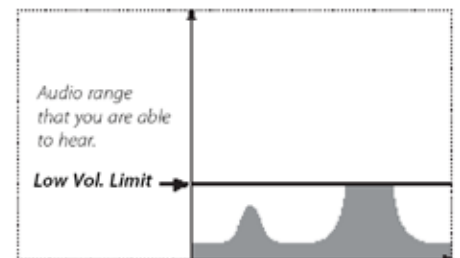
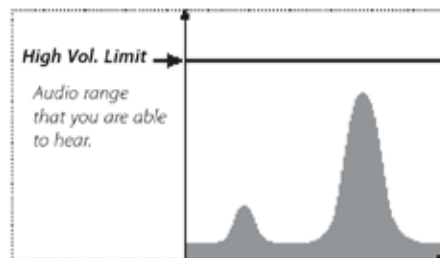

Figure 20 – Volume Limit

Threshold Pitch

Range: 1–30

Factory Preset: 15

Threshold Pitch allows you to adjust the pitch of the Threshold tone. Hearing will vary between individuals, so adjust the Threshold Pitch to a level that is comfortable for your hearing.

Menu

For information on the Menu Button and its use, refer to page 29.

User Button



User Button

- › Press to activate your selected function
- › Press and hold to assign a function to the user button

User Button

The purpose of the User button is to provide easy access to your favorite functions. There are nine different functions that can be assigned to the User button, and once a function has been assigned, it will be activated each time the button is pressed. By default, pressing the User button will activate the Backlight.

The available User button functions are:

- Backlight (*default*)
- Previous Mode
- Pinpoint Type
- Target Trace Pinpoint
- Large ID Panel
- Navigation Tool
- Sensitivity Panel
- Coordinate View
- Target ID Panel

User Button Functions

Backlight

Backlight is the default function assigned to the User button; press to toggle the backlight on and off.

If the backlight is not controlled by the User Button, it will automatically activate on pressing a button as determined by backlight settings in the Options menu (*page 49*).

Previous Mode

Press to toggle between current and previous modes.

Pinpoint Type

Press to toggle between Normal and Sizing Pinpoint types.

Once the Pinpoint Type function is assigned to the User button it will also control the Pinpoint settings in the Modes menu.

Target Trace Pinpoint

Press to toggle Target Trace Pinpoint on and off.

Large ID Panel

Press to toggle the Large ID Panel on and off.

Navigation Tool

Press to toggle the Navigation Tool on and off.



NOTE

Only the Backlight function can be used from the menu screens. All other User assigned functions must be used from the Detect or Map screens.

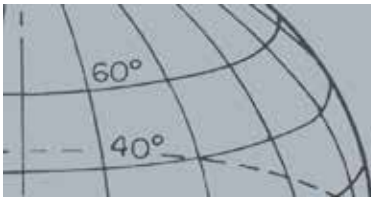

User Button

Sensitivity Panel

Press to toggle the Sensitivity Panel on and off.

Coordinate View

Press to toggle the Latitude/Longitude coordinates on and off.

Target ID Panel

Press to toggle the Target ID Panel on and off.

Assign a Function to the User Button

1. Press and hold the User button to display a list of functions that can be assigned to the button.
2. Use the down arrow button to highlight the required function and press Select.
The selected function will be assigned to the user button. That function will be activated each time the User button is pressed.

Pinpoint

Pinpointing narrows down the location of a buried target, allowing you to determine its exact location before digging.

Normally the CTX 3030 is a 'motion' detector; it must be moving over a target in order to detect it. When Pinpoint is activated, the CTX 3030 will operate as a non-motion detector, producing a constant audio response while the coil is held still over a target. Pinpoint instructs the detector to temporarily disengage the Discrimination Pattern, thereby allowing the detection of all targets underneath the coil. Detection results, such as FE-CO coordinates and depth, are still updated.

Activate Pinpoint

Activate Pinpoint by holding the Trigger from the Detect or Map screens.

When Pinpoint is activated, a gauge will appear at the bottom of the detection screen. This gauge will move from the outsides to the centre as the coil is moved closer to the target.



Figure 21 – Pinpoint activated

The audio response to the target will also change; both pitch and volume will increase as the coil approaches the target.

Pinpoint the Target

1. Once the approximate target location is known, move the coil to one side of that location and press and hold the Trigger.
2. Sweep the coil slowly across the target location keeping the coil parallel to the ground while holding the Trigger.
3. Taking note of the response, locate the centre of the target by listening for the loudest signal or watching the red ball on the Pinpoint Gauge. Make a mental note of the position, or mark a line on the soil with your shoe or a digging tool.
4. Move to one side so that you can pass the coil over the target at right angles to your initial direction (*Figure 22*).

Repeating steps one to three in the new direction will give an exact location to dig.

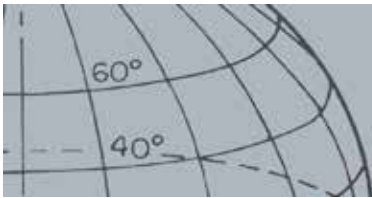

Pinpoint

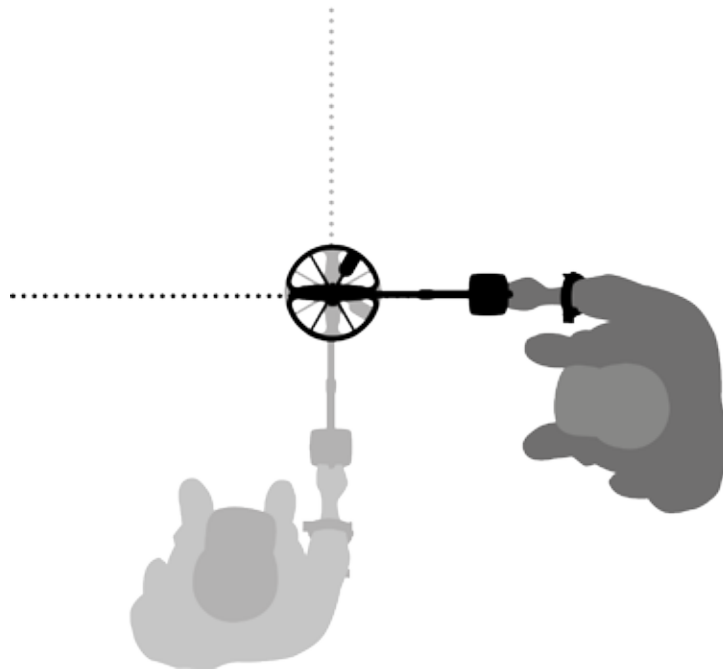

Figure 22 – Pinpointing the target

For more information on Pinpoint options, see page 42.



Menu/Select Button

- › Press from the Detect/Map screens access the menus
- › Press from within the menu screens to select an option

CTX 3030 Menus

The Main Menu screen provides you with access to all of CTX 3030's functions and settings. Press and hold the Menu button from the Detect or Map screens to display the top-level menu screen, or press to view the last used menu function.

Using the Menus

Press the Menu/Select button to view the top-level menu screen. This screen will display the four main menu icons, with the Modes menu highlighted by default. Use the CTX 3030 control buttons to move through the menu options (*Figure 23*).

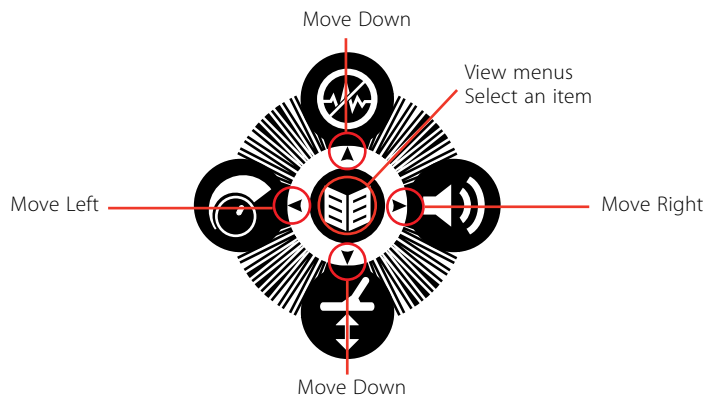

Figure 23 – CTX 3030 control buttons

On the Main Menu screen, use the left and right arrow buttons to move between the four main menu options. Press the Select button to activate the menu of your choice.

When a menu is active, use the up and down arrow buttons to highlight each available option in turn. Press the Select button to activate your selection.

Menu Symbols

	More Menu	Arrow Right or Select to view submenus
	Check box	Blank check box - Menu option is not currently selected Ticked check box - Menu option is currently selected
	Radio Button	Blank Radio Button - Menu option is not currently selected Green Radio Button - Menu option is currently selected

Table 24 – Summary of CTX 3030 menu symbols



NOTE

Menu options that appear 'greyed out' are not available for selection.



NOTE

Radio Buttons only allow one option to be selected, whereas check boxes allow the selection of multiple options.

CTX 3030 Menus

Menu Types

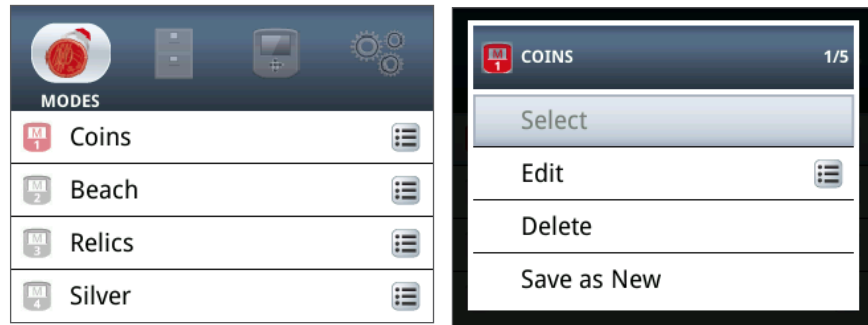

Figure 25 – Menu and Quick Menu

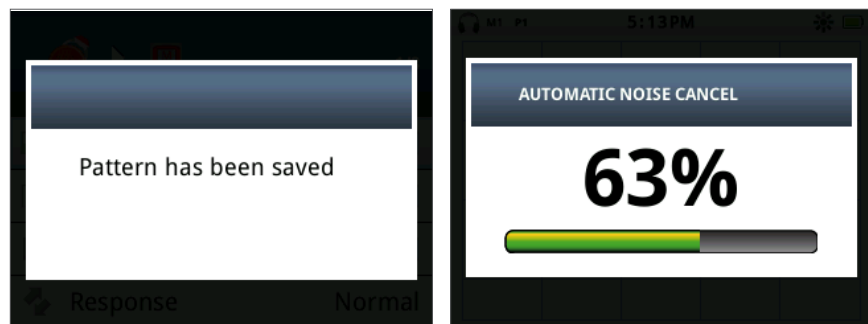

Figure 26 – Dialog and Progress Bar

Menu Structure

All functions and settings are grouped into four menu options:

- Modes
- GeoStore
- Display
- Options

The following overviews provide a quick reference guide to each menu. More detailed information is provided from page 32 to page 48.

Modes Menu Overview

Modes	Actions	Mode Settings	Available Settings
Mode 1 - Coins	Select	Pattern 1	Discrimination Pattern 1 Editing
Mode 2 - Beach	Edit	Pattern 2	Discrimination Pattern 2 Editing
Mode 3 - Relic	Delete	Tone ID Profile	Tone ID Profile Editing
Mode 4 - Silver	Save as New	Response	Normal, Long, Smooth, Pitch Hold
Mode 5 - High Trash	Reset Mode	Recovery Fast	On/Off
Mode 6		Recovery Deep	On/Off
Mode 7		Seawater	On/Off
Mode 8		Target Separation	Low Trash /High Trash/Ferrous-Coin/ Ground-Coin
Mode 9			
Mode 10		Pinpoint	Normal/Sizing



Modes Menu



NOTE

Modes 6 to 10 will only appear in the menu once they have been created.

CTX 3030 Menus



GeoStore Menu

GeoStore Menu Overview

Options	Sort Options	View	Actions
FindPoints WayPoints	Distance Time Name	FindPoint List WayPoint List	Go to FindPoint/WayPoint View Delete
GeoHunts		GeoHunt List	Go to start Go to end Delete



Display Menu

Display Menu Overview

Options	View	Outcomes
Detect Screen	Large ID Panel Navigation Tool Sensitivity Panel	Selected item is displayed on the Detect screen
Map Screen	Coordinate View Navigation Tool Target ID Panel	Selected item is displayed on the Map screen



Options Menu

Options Menu Overview

Options	Actions	Outcomes
Wireless	Wireless Enable Connect	On/Off Channel Selection/Confirmation Message
GPS	GPS Location Format GPS Time Sync	Off/On/Enhanced D.MS or D.M On/Off
Locality	Set Time Time Zone Time Format Units	Edit hours and minutes UTC -01:30 to UTC +12:00 12/24 hour Yards/Meters
Backlight	Brightness Backlight	1 to 10 Off 10 seconds 30 seconds On
Pinpoint Lock		On/Off

Modes Menu



Modes Menu

- › Select a mode
- › Delete a mode
- › Create a new mode
- › Reset mode to default
- › Edit mode settings

Modes Menu

Search Modes

The CTX 3030 has up to ten search modes. These can be set up to suit particular detecting conditions, eliminating the need to adjust your detector for each different site you visit. Modes can be optimized for different target types, amounts of junk and levels of ground mineralization. The currently selected mode can be edited. New modes are created by copying existing modes. Search modes are selected, saved and edited through the Modes menu, which initially contains five preset modes, and facilitates the creation of five additional modes as follows:

- Mode 1 (M1) - Coins
- Mode 2 (M2) - Beach
- Mode 3 (M3) - Relics
- Mode 4 (M4) - Silver
- Mode 5 (M5) - High Trash
- Mode 6 (M6)
- Mode 7 (M7)
- Mode 8 (M8)
- Mode 9 (M9)
- Mode 10 (M10)

Each mode comprises a number of functions, which are displayed under the Mode Settings menu. Each function can be customized to create a mode that suits specific detecting conditions. The factory presets for each mode are shown on page 55.

Open the Modes Menu

1. Press and hold the Menu button to display the Main Menu screen.
The Modes menu will be selected by default and your current list of search modes will be displayed.
2. Use the arrow buttons to highlight the search mode you require and press Select.
The selected Mode Quick Menu will be displayed with the following options:
 - Select
 - Edit
 - Delete
 - Save as New
 - Reset Mode

Select a Mode

1. From the Modes menu, use the down arrow button to highlight the mode of your choice and press Select.
2. Use the arrow buttons to highlight the Select option from the pop-up and press the Select button.



NOTE

Only the currently selected search mode can be edited.

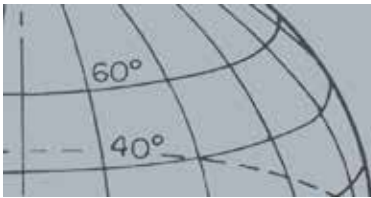

Modes Menu

The detector will return to the Detect screen and your selected mode will be active. The mode number will be displayed on the Status Bar.

Delete a Mode

1. From the Modes menu, use the down arrow button to highlight the mode of your choice and press Select.
2. Use the arrow buttons to highlight the Delete option from the pop-up and press the Select button.

A message will be displayed to confirm that the mode has been deleted, and you will be returned to the Modes menu. The deleted mode will no longer be listed.

Create a New Mode

New search modes are created by copying an existing mode. Up to ten search modes are available.

To create a new search mode:

1. From the Modes menu, use the arrow buttons to highlight the mode you want to copy and press Select.
2. From the mode pop-up, use the arrow buttons to highlight the Save as New option and press Select.

You will be returned to the Modes menu and the new search mode will be listed. Initially this mode will retain the properties of the mode from which it was created and will be the currently selected mode. It can now be edited to suit your requirements.

Reset a Mode to Default

Newly created and edited search modes can be reset to any of the preset modes. This menu option is only available when a new mode has been created.

To reset a new search mode:

1. Use the arrow buttons to highlight the mode you want to reset and press Select.
2. From the selected mode pop-up, use the down arrow buttons to highlight the Reset to Default option and press Select.

The list of default modes will be displayed.

3. Use the arrow buttons to highlight the default mode you require and press select.

You will be returned to the Modes menu and your mode will be reset and renamed to the selected default mode.

Edit a Mode

The currently selected search mode can be edited through the Mode Settings menu. If the mode you want to edit is not the current mode, first follow the steps to 'Select a Mode' (page 32) so that the edit option becomes available.



NOTE

Modes can be renamed using the XChange 2 application.



Modes Menu

Mode Settings

- › Edit Discrimination Patterns
- › Edit Tone ID Profile
- › Adjust Response settings
- › Turn Recovery Fast On/Off
- › Turn Recovery Deep On/Off
- › Turn Seawater On/Off
- › Select Target Separation setting
- › Select Pinpoint type

Mode Settings

Each search mode has a number of mode specific functions which can be viewed and adjusted through the Mode Settings menu. These functions are as follows:

- Pattern 1
- Pattern 2
- Tone ID Profile
- Response
- Recovery Fast
- Recovery Deep
- Seawater
- Target Separation
- Pinpoint

Open the Mode Settings Menu

1. From the Modes menu, use the down arrow button to highlight the mode of your choice and press Select.

The Mode pop-up will be displayed.

2. Use the down arrow to highlight the Edit option and press Select.

The Mode Settings menu will be displayed.

Pattern 1 and Pattern 2

The CTX 3030 has two discrimination patterns for each search mode – Pattern 1 (P1) and Pattern 2 (P2). Pattern 1 is selected by default when the Mode Settings menu opens. Pattern editing options are available through the Edit Type menu.

Open the Edit Type Menu

1. From the Mode Settings menu, press Select to display Pattern 1 or use the down arrow button to highlight Pattern 2 and press Select.

The selected Discrimination Pattern will be displayed.

2. Press the Select button again to display the Edit menu with the following options:
 - Edit Type
 - Accept All
 - Reject All
 - Exit

The Edit Type option will be highlighted and the current Edit Type will be displayed on the right hand side of the screen.

3. Press Select to display the Edit Type menu with the following options:

- Manual
- Auto Accept
- Auto Reject

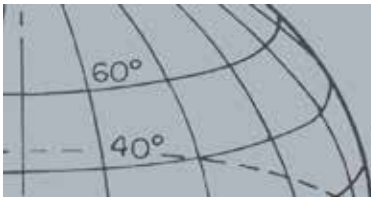

Modes Menu

Edit Types

Manual

Use Manual editing to manually move the Edit Frame around the Discrimination Pattern. You can use the Identify button to edit areas of the pattern to accept (*white areas*) or reject (*grey areas*) certain targets. Remember that using a larger Edit Frame will change the exact target coordinates plus one or two segments either side.

Auto Accept

Use Auto Accept to automatically modify the Discrimination Pattern to accept the Ferrous and Conductivity coordinates of a detected target.

Auto Reject

Use Auto Reject to automatically modify the Discrimination Pattern to reject the Ferrous and Conductivity coordinates of a detected target.

Select an Edit Type

1. From the Edit Type menu use the arrow buttons to highlight your required option and press Select.

The Pattern screen will be displayed.

2. Press Select again to return to the Edit menu.

Your chosen Edit Type will be displayed on the right hand side of the screen.

3. Use the down arrows to highlight the Exit option and press Select.

You will be returned to the Mode Settings menu.

Select Accept All or Reject All

1. From the Edit menu, use the down arrow buttons to highlight the Accept All or Reject All option and press Select.

The updated Pattern screen will be displayed. If you selected Accept All the entire pattern will be white, and if you selected Reject All the entire pattern will be shaded.

2. Press Select to return to the Edit menu.

3. Use the down arrow button to highlight and select Exit option and press Select.

The Save Pattern menu will be displayed.

4. Select Yes to save changes or No return to the Mode Settings menu.

When Yes is selected, a confirmation message will be displayed and you will be returned to the Mode Settings menu. Select No to discard the changes and return to the Mode Settings menu.



Modes Menu

Tone ID

- › Select/change the Tone ID Profile Type
- › Resize sections of the Tone ID Profile
- › Change the pitch of the current Tone ID
- › Play the currently selected tone
- › Play all tones

Tone ID Profile

Range: 1, 2 FE/CO, 4 FE/CO, 35 FE, 50 CO or Combined

The Tone ID menu allows you to define how the tone of the audio varies when different target characteristics are detected. This is very useful for identifying targets close to each other.

Open the Tone ID Menu

1. From the Mode Settings menu, use the arrow down button to highlight the Tone ID Profile option and press Select.

The current Tone ID Profile will be displayed.

2. Press Select again to display the Tone ID Profile menu with the following options:
 - Profile Type
 - Resize
 - Change Pitch
 - Play Tone
 - Play All
 - Exit

Profile Type

Selection of the Profile Type dictates how many different tonal responses there are while detecting. The available options are:

- 1 – all targets emit a single tone
- 2 CO – targets can be two tones depending on their Co reading
- 2 FE – targets can be two tones depending on their Fe reading
- 4 CO – targets can be four tones depending on their Co reading
- 4 FE – targets can be four tones depending on their FE reading
- 35 FE – targets can be 35 tones depending on their FE reading
- 50 – targets can be 50 tones depending on their CO reading
- Combined – a combination of FE/CO tones

To change or select the Tone ID Profile Type:

1. From the Tone ID Profile menu, highlight and select the Profile Type.
2. Use the arrow buttons to highlight the Profile Type you require and press Select.
The selected Tone ID Profile will be displayed.
3. Press Select to confirm your choice and return to the Tone ID Profile menu.
4. Use the down arrow button to highlight Exit and press Select to return to the Mode Settings menu.

Modes Menu

Resize the Tone ID Profile

The Resize option allows you to manually resize each section of the Tone ID Profile.

1. From the Mode Settings menu, highlight the Tone ID Profile option and press Select.

Your current Tone ID Profile will be displayed.

2. Use the arrow buttons to highlight the section of the Tone ID Profile you want to edit (*the active section will change color*) and press Select.

The Tone ID Profile menu will be displayed.

3. Use the arrow buttons to highlight the Resize option and press Select.

The Tone ID Profile will be displayed. The active section will be displayed in a different color with a numbered marker on each side of the highlighted section.

4. Use the arrow buttons to increase or decrease the size of the highlighted section to your requirements and press Select.

Your edited Tone ID profile will be displayed.

5. Repeat steps 1 to 4 as required.

6. When editing is complete, press Select to return to the Tone ID Profile menu.

7. Use the down arrow button to highlight Exit and press Select to return to the Mode Settings menu.

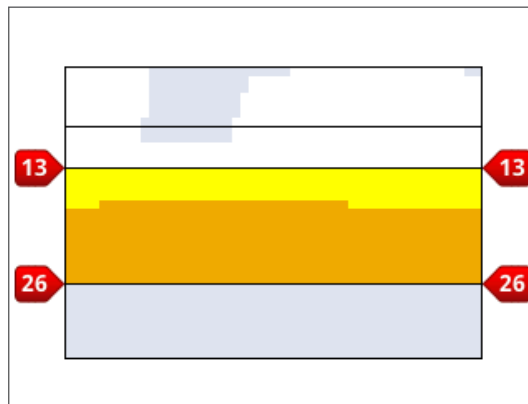

Figure 27 – Resize Tone ID Profile section

Change Pitch

1. From the Mode Settings menu, highlight the Tone ID Profile option and press Select.

Your current Tone ID Profile will be displayed.

2. Use the arrow buttons to highlight the section of the Tone ID Profile you want to edit and press Select.

The Tone ID Profile menu will be displayed.

3. Highlight the Change Pitch option and press Select.

The Tone ID Profile will be displayed with the section to be edited highlighted. The pitch setting will have a cursor below the number to be changed.

Modes Menu

4. Use the left and right arrow buttons to move the cursor to each number in turn; increase or decrease each number using the up and down arrows.
5. When editing is complete, press Select.
6. The Tone ID Profile will be displayed with your updated pitch.
7. Press Select to return to the Tone ID Profile.
8. Repeat steps 1 to 7 for each section you want to edit.

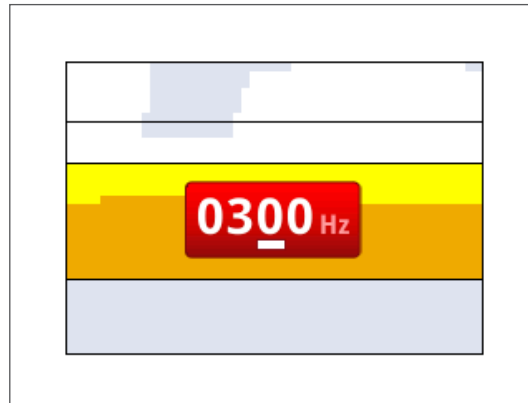

Figure 28 – Change Pitch



NOTE

Tones can only be played through the detector speaker, not through the WM 10.

Play Tone

The Play Tone option allows you to listen to one selected tone in your Tone ID Profile.

1. From the Tone ID Profile menu, highlight the Play Tone option and press Select.
The currently selected tone will sound.

Play All

The Play All option allows you to listen to all tones in your current Tone ID Profile.

1. From the Tone ID Profile menu, highlight the Play All option and press Select.
The current Tone ID Profile will be displayed and each tone will sound.

Response

Range: Normal, Long, Smooth and Pitch Hold

The Response setting changes the way target signals sound upon detection. Response can improve your ability to identify certain targets in different conditions, such as high trash, mineralized ground and beaches.

As the coil is swept over a target, the target signal rises. At the peak of the target signal, audio is emitted. Minelab recommends initially learning how to operate the detector in the Factory Preset 'Normal' audio Response.

The Response options are:

- Normal
- Long
- Smooth
- Pitch Hold

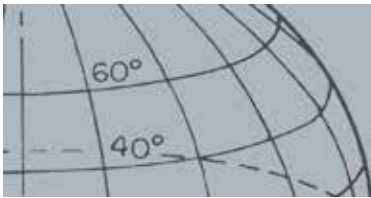

Modes Menu

Normal

Normal emits a short response to targets (*almost a 'beep'*). Normal is recommended for general detecting conditions. It allows the greatest differentiation between the ground and a target, but has the potential to miss small targets in areas littered with objects producing target responses.

Long

Long emits an almost continuous audio response. This setting is ideal for responding to several targets close together. Long can be a little confusing for the beginner but has the potential to offer greater Tone ID accuracy and depth to the experienced user who can pick the tonal differences between various targets.



NOTE

Even though you can still select Pitch Hold when the No. of Tones is set to 1, it will not have any effect on the target audio response.

Smooth

The Smooth setting is similar to Long, with the addition of some filtering of the audio tone response. Smooth reduces the variability of the pitch, offering a smoother continuous sound.

Pitch Hold

When Pitch Hold is selected, the normal rise-and-fall target signal is replaced with a continuous tonal response. The tone emitted is the strongest signal coming from the target, and will continue until a new target is detected.

Change the Response

1. From the Mode Settings menu, use the down arrow button to highlight the Response option and press Select.
The Response menu will be displayed.
2. Use the down arrow button to highlight the option of your choice (*only one option at a time can be selected*) and press Select.

You will be returned to the Mode Settings menu and your new selection will be displayed next to the Response option on the menu.

Recovery Fast and Recovery Deep

The Recovery Fast and Recovery Deep settings allow you to select the way the discrimination process works. Recovery settings affect the detector's audio and its display response to target characteristics.

Recovery Fast

When Recovery Fast is active, the detector will react faster to target signals, but the discrimination and Target ID may be slightly less accurate.

Use this setting in areas littered with objects, where a desired target could be hiding next to unwanted objects.

If there are two targets very close together that cause a single detection, the signal processing that is usually employed when Recovery Fast is off may cause a blending of the Target IDs, giving a Target ID somewhere between the two actual IDs (*Figure 29*).

Modes Menu

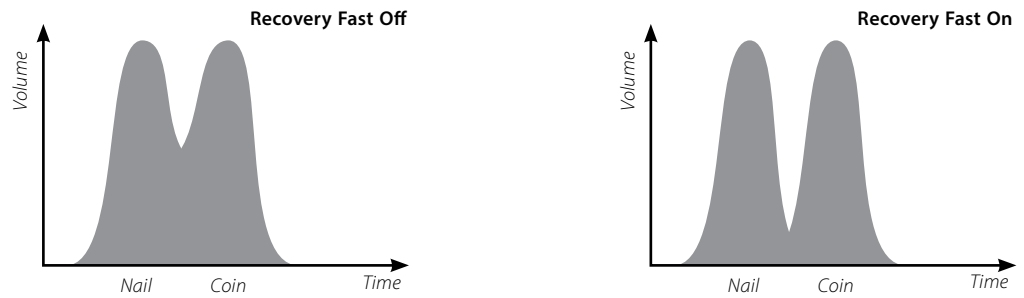

Figure 29 – Blending of Target IDs

The two Target IDs may still be slightly less accurate than ideal, however when Recovery Fast is off, the ID will be more variable and may not resemble either of the targets.

In the example shown (Figure 29), using Recovery Fast will provide two distinct target IDs in each direction, whereas when Recovery Fast is off the ID will be more variable and may not resemble either of the targets.



NOTE

Minelab recommends turning Recovery Fast On when Trash Density is set to High

Turn Recovery Fast On/Off

1. From the Mode Settings menu, use the down arrow button to highlight the Recovery Fast option and press Select.
A green tick will appear in the check box indicating that Recovery Fast is on.
2. Select the Recovery Fast option again to remove the green tick and turn Recovery Fast off.

Recovery Deep

The Recovery Deep setting only affects weak target signals (*strong signals are unaffected*), enhancing identification of deep targets. It should only be used in relatively uncluttered areas where deep targets are anticipated. When Recovery Deep is in use there will be a slightly slower reaction in target signal and Target ID due to the extra signal processing that is employed.

Turn Recovery Deep On/Off

1. From the Mode Settings menu, use the down arrow button to highlight the Recovery Deep option and press Select.
2. Select the Recovery Deep option again to remove the green tick and turn Recovery Deep off.

Seawater

When detecting with the coil submerged in salt water, use the Seawater function to maintain a higher Sensitivity level for maximum depth without the occurrence of false signals. For maximum depth the Sensitivity level may need to be adjusted when detecting in deeper/shallower water.

When detecting on the beach out of the water or inland turn the Seawater function off.

Modes Menu



NOTES

With Seawater on, keeping your sweep speed as fast as possible will provide maximum depth.

Most beaches are non-mineralized, therefore greater depth can be achieved using the highest stable Manual Sensitivity setting.

DO NOT Ground Balance at the beach – leave GB disabled.

Turn Seawater On/Off

1. From the Mode Settings menu, use the down arrow button to highlight the Seawater option and press Select.

A green tick will appear in the check box indicating that the Seawater setting is on.

2. Select the Seawater option again to remove the green tick and turn Seawater off.

Target Separation

Range: Low Trash/High Trash/Ferrous-Coin/Ground-Coin

Target Separation allows you to optimize the signal processing to suit your detecting conditions. The Target Separation settings are:

- Low Trash – targets in a low trash density environment
- High Trash – targets in a high trash density environment
- Ferrous-Coin – coins in a high density FE trash environment, low mineralization
- Ground-Coin – coins in ground with high mineralization

	Desirable Targets		Ground	Targets + Junk	Undesirable Junk	
	FE Target	Non-FE Target	Mineralization	Sparse	FE Clutter	Non-FE Clutter
Low Trash	✓	✓	Low/Med	✓		
High Trash	✓	✓	Low/Med		✓	✓
FC Separation	✗	✓	Low		✓	✗
GC Separation		✓	High	✓		

Table 30 – Target Separation Matrix

Low Trash

The Low Trash setting provides very stable Target ID's in areas with low trash and low to medium levels of mineralization. This allows you to create very narrow discrimination patterns for specific targets.

Using the Low Trash setting in High Trash areas is not recommended because a strong rejected target in close proximity can cause a good target to be masked or hidden. The Low Trash setting will respond to whichever target has the strongest target signal and will ignore the other target.

High Trash

The High Trash setting can identify weak accepted target signals amongst rejected targets even if the rejected target signals are stronger. The advanced signal processing takes the best accepted target signal and ignores all the rejected target signals no matter how strong they are. When High Trash is used, the Target ID is less stable, therefore a larger edit frame will be required in order to accept or reject specific targets. High Trash can also be used with a slightly faster sweep speed, making it suitable for areas where fast ground coverage is important, such as during competition hunts. The High Trash setting also offers improved target ID stability in highly mineralized ground conditions.



Modes Menu



NOTE

The Ferrous-Coin setting may not always provide audio.

Ferrous-Coin

Ferrous-Coin improves the Target ID stability of coin type targets amongst ferrous targets in areas with low mineralization. This setting uses advanced signal processing techniques to minimize the blending of ferrous and coin type target signals even when they are on top of each other. Both targets will be more accurately identified and their cursors displayed simultaneously on the Detect screen.

If both targets happen to be in an accepted areas of the screen, such as when using a fully open/All Metals discrimination pattern, the Target ID number displayed will be from the coin type object.

Ground-Coin

Ground-Coin improves Target ID stability of coin type targets in areas with high ground mineralization. Ground with high mineralization would normally spread the Target ID over a wide area of the detect screen, with the potential to misidentify targets. This setting uses advanced signal processing techniques to minimize the blending of ground and coin signals. The improvement in Target ID stability allows you the best opportunity to correctly identify the good target.

Select Target Separation Settings

1. From the Mode Settings menu, use the down arrow buttons to highlight the Target Separation option and press Select.
The Target Separation menu will be displayed.
2. Use the arrow buttons to highlight your required Target Separation setting (*only one option at a time can be selected*) and press Select.

You will be returned to the Mode Settings menu and your Target Separation selection will be displayed.



NOTE

Changing the coil height during Pinpointing can make the target disappear altogether.

Pinpoint

The Pinpoint menu options allow you to choose between the two Pinpoint types:

- Normal
- Sizing

Normal

After activating the Normal Pinpoint function, the first sweep over the target will generate a wide audio response. With each successive sweep, the width of the audio response will be automatically reduced until there is only a very narrow response at the centre of the search coil indicating the targets location. Make a mental note of the position, or mark a line in the soil with your shoe or digging tool. Move to one side so that you can pass the coil over the target at right angles (90 degrees) and pass the coil over the target again until only a narrow response is heard. Mark the position again and X marks the spot.

Modes Menu

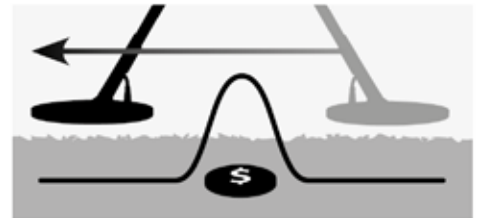
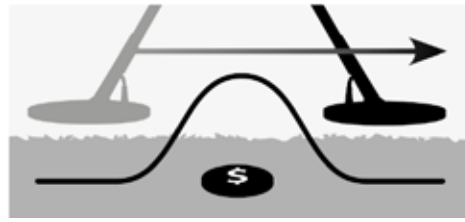

Figure 31 – Wide and narrow audio responses

Sizing

After activating the Sizing Pinpoint function the width of the audio response does not change. Activating the Sizing Pinpoint as you near the target allows you to manually control the width of the target response. Activating the Sizing Pinpoint whilst the coil is away from the target and then approaching the target from different directions allows the extent of the target to be determined.

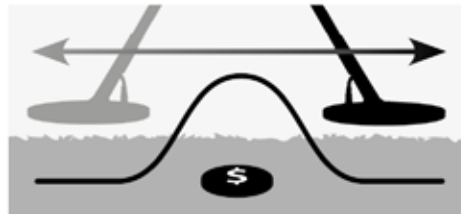

Figure 32 – Full and masked audio responses



NOTE

Do not activate Pinpoint with detector positioned over the centre of the target or the whole target may be masked.

Activate Pinpoint

From the Map or Detect screens, press the trigger to activate Pinpoint; deactivate it by releasing the trigger (see page 50 for other activation options). The default Pinpoint Type is 'Normal'.



Change Pinpoint Type

1. From the Mode Settings menu, use the down arrow buttons to scroll to the Pinpoint option and press Select.
The Pinpoint menu will be displayed.
2. Use the arrow buttons to highlight your required option and press Select.
3. You will be returned to the Mode Settings menu and your selection will be displayed next to the Pinpoint option.

GeoStore Menu



GeoStore

- › Sort WayPoints/FindPoints
- › Go to a FindPoint/WayPoint
- › Delete a FindPoint/WayPoint/GeoHunt
- › Go to the start or end of a GeoHunt



NOTE

GPS must be enabled and a valid GPS position fix established before using the GeoStore menu.

GeoStore Menu

The GeoStore menu allows you to store, sort and view up to 100 FindPoints, 100 WayPoints and 10 GeoHunts. Each time you save a FindPoint, WayPoint or GeoHunt, a name is automatically assigned to each item using the following naming convention:

- FindPoint – FP001, FP002 to FP100
- WayPoint – WP001, WP002 to WP100
- GeoHunt – GH01, GH02 to GH10

Names assigned by the detector can be changed using the XChange 2 application. FindPoints and WayPoints can be deleted on the detector, but cannot be edited.

Open the GeoStore Menu

1. Press and hold the Menu button to display the main menu.
2. Use the right arrow button to highlight the GeoStore option and press Select.
3. The GeoStore menu will be displayed with the following options:
 - FindPoints
 - WayPoints
 - GeoHunts

Sort FindPoints/WayPoints

1. From the GeoStore menu, use the arrow buttons to highlight FindPoints or WayPoints and press Select.
The Sort menu will be displayed with the following options:
 - Distance (*from your current location*)
 - Time
 - Name (*alphabetically*)
2. Use the arrow buttons to highlight your preferred sort mode and press Select.
The sorted list will be displayed.

Go to a FindPoint or WayPoint

1. Display the sorted list for your preferred option (*FindPoints or WayPoints*).
2. Use the arrow buttons to highlight the name of the item you want to 'go to' and press Select.

The FindPoints or WayPoints options menu will be displayed with the following options:

- Go to
- View
- Delete

By default the 'Go to' option will be highlighted.

GeoStore Menu



Destination Icon



NOTE

The Destination Icon only appears when the Navigation Tool is turned on.

3. Press Select.
4. Turn on the Navigation Tool (*page 46*)

The map screen will be displayed showing a Destination icon, which represents your selected FindPoint or WayPoint. The Navigation Tool will indicate the direction and distance to your destination.

Go to Start/End of a GeoHunt

1. From the GeoStore menu, use the arrow buttons to highlight the GeoHunts option and press Select.

The pop-up will be displayed with the following options:

- Go to start
- Go to end
- Delete

2. Use the arrow buttons to highlight your required option and press Select.

Delete a GeoStore Item

Individual FindPoints, WayPoints and GeoHunts can be deleted from the GeoStore. To delete a GeoStore item:

1. From the GeoStore menu, use the arrow buttons to highlight your preferred option and press Select

The pop-up will be displayed with the following options:

- Go to
- View
- Delete

2. Use the arrow buttons to highlight the Delete option and press Select.

Your item will be deleted and a confirmation message will be displayed.

Display Menu



Display

- › Show or hide Detect screen items
- › Show or hide Map screen items



NOTE

The large Target ID Panel will only appear on the Detect screen when a target is detected.

Display Menu

The Display menu is where you control which items you want to appear on the Map and Detect screens.

Open the Display Menu

1. Press and hold the Menu button to display the Main Menu screen.
2. Use the arrow buttons to highlight the Display option and press Select to open the Display menu.

Show or Hide Detect Screen Items

1. From the Display menu, use the down arrow button to highlight the Detect Screen option and press Select.

The Detect options menu will be displayed with the following options:

- Large ID Panel (*FE-CO*)
- Navigation Tool
- Sensitivity Panel

2. Use the arrow and select buttons to highlight and select the item/s you want to show.

A green tick will appear in the check box for each item selected.

3. Press the Detect button to return to the Detect screen.

The selected items will be visible.

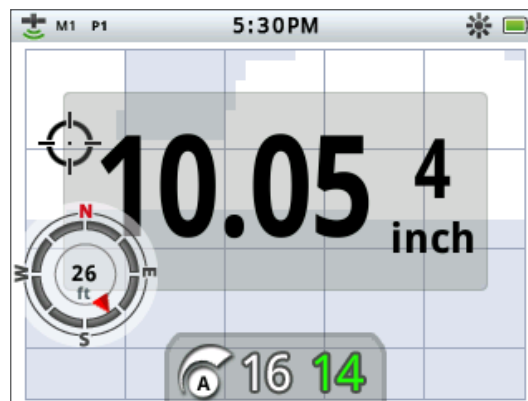

Figure 33 – Detect screen showing optional items

Display Menu



NOTE

The Target ID Panel will only appear on the Map screen when a target is detected.

Show or Hide Map Screen Items

1. From the display menu, use the down arrow button to highlight the Map Screen option and press Select to open the Map menu.

The Map options menu will be displayed with the following options:

- Coordinate View (Lat/Long)
- Navigation Tool
- Target ID Panel (FE-CO)

2. Use the arrow buttons to scroll through the options and press Select on the items you want to show.

A green tick will appear in the check box for each item selected.

3. Press the Map button to return to the Map screen.

The selected items will be visible.

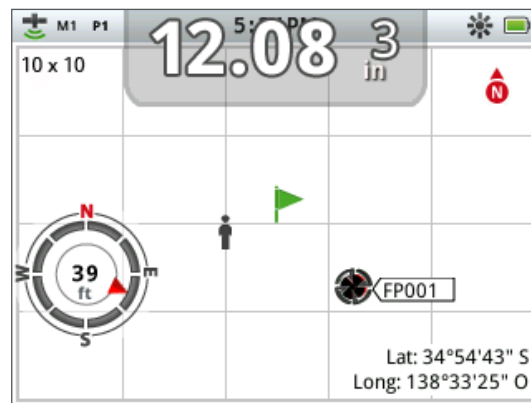

Figure 34 – Map screen showing optional items

Options Menu



Options

- › Enable Wireless
- › Connect Wireless
- › Enable GPS
- › Select location format for GPS
- › Set GPS time sync
- › Set time preferences
- › Set linear units preferences
- › Set backlight preferences
- › Set Pinpoint button preference



NOTE

Once GPS is enabled, it may take several minutes before good fix quality is achieved.

Options Menu

The Options menu is where you can select and edit the following detector settings:

- Wireless
- GPS
- Locality
- Backlight
- Pinpoint Lock

Open the Options Menu

1. Press and hold the Menu button to display the main menu.
2. Use the arrow buttons to highlight Options and press Select to display the Options menu.
3. Use the up and down arrow buttons to highlight your desired setting and press Select.

Wireless Settings

The Wireless menu will be displayed with the following options:

- Wireless Enable - must be selected before connection can take place
- Connect - provides wireless connection to WM 10 (*see page 53*).

GPS Settings

The GPS menu will be displayed with the following options:

- Enable (Off, On, Enhanced)
- Location Format (D.MS, D.M)
- GPS Time Sync

Enable

The Enable setting has three options:

- Off
- On
- Enhanced

GPS Enable must be 'On' before any other settings can be selected.

The Enhanced setting turns on the Satellite Based Augmentation System (SBAS), which improve GPS accuracy. This setting must only be selected in locations where SBAS (*or Wide Area Augmentation System*) is available.

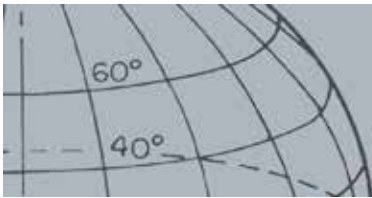

Options Menu

Location Format

The Location Format provides the conversion of latitude and longitude coordinates. There are two available options:

- D.MS – Degrees°minute’sseconds” (e.g. 40° 45’ 3.6” N 73° 59’ 0.24” W)
- D.M – Degrees°minute.decimal’ (e.g. 40° 45.06 , -73° 59.004’)

GPS Time Sync

GPS Time Sync sets the time based on information from the GPS. Before this setting can be used, GPS must be enabled and the Time Zone must be set.

Locality Settings

The Locality menu will be displayed with the following options:

- Set Time
- Time Zone
- Time Format
- Units

Set Time

Set Time allows you to change or set the current time. This option is only available if GPS Time Sync is not selected.

Time Zone

Time Zone is based on Universal Coordinated Time (UTC), and options range from UTC - 01:30 to UTC + 12:00.

Time Format

Time Format options are 12 and 24 hours.

Units

Units can be configured to yards or meters and represent units of measure for depth, maps and navigation.

Backlight Settings

Brightness

Backlight brightness can be set in single increments ranging from 1 to 10.

Backlight

The Backlight settings are only available when the Backlight is not controlled by the user buttons.

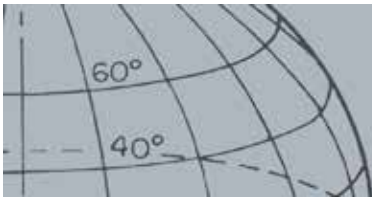

Options Menu

The options are:

- Off – Backlight is always off
- 10 seconds – Backlight turns on when button is pressed and automatically turns off after 10 seconds
- 30 seconds – Backlight turns on when button is pressed and automatically turns off after 30 seconds
- On – Backlight is always on

Pinpoint Lock

The Pinpoint trigger can be used in two ways:

- Press and hold to Pinpoint (default)
- Press to lock the detector in Pinpoint, press again to exit Pinpoint

To activate the Pinpoint Lock function, highlight the Pinpoint Lock option and press Select.



Reset the CTX 3030

Reset

- › Reset the GeoStore
- › Reset Settings
- › Reset All
- › Reset Language (default US English)

Reset the CTX 3030

The CTX 3030 is delivered in its factory preset state and any changes made to the detector's settings are saved automatically. These settings will remain until you manually change or reset them using the Reset menu.

Open the Reset Quick Menu

1. With the detector switched off, press and hold the power button.
The detector will power up and play the startup tune.
2. Keep holding the button until you hear a low tonal sound, and then release the button.

The Reset menu will be displayed with the following options:

- Reset GeoStore
 - Reset Settings
 - Reset All
 - Language
3. Use the arrow buttons to highlight the option you require and press Select.

Reset GeoStore

Select the Reset GeoStore option to clear the contents from the GeoStore. All FindPoints, WayPoints and GeoHunts will be deleted.

When the GeoStore has been cleared a confirmation message will be displayed.

Reset Settings

Select the Reset Settings option to clear all user settings and delete user search modes. Information in the GeoStore (FindPoints, WayPoints, GeoHunts) will not be affected.

When Reset Settings has been completed the detector will reboot.

Reset All

Select the Reset All option to return all settings to their factory preset levels, delete all search modes and empty the GeoStore.

When Reset All has been completed the detector will reboot. When start-up is complete the detector will prompt you to select your language before displaying the Detect screen.



Reset the CTX 3030



NOTE

When changing the language from English, only some of the mode names will be changed to the newly selected language.

Language

The CTX 3030 Graphical User Interface (GUI) can be displayed in one of nine different languages (default US English). You will be prompted to select the detector language on initial startup, and when the detector reboots following a Reset All. The language can also be changed at any time using the Reset menu.

Reset the Language

1. From the Reset menu, use the down arrow button to highlight the Language option and press Select to open the Language menu.
2. Use the arrow buttons to highlight the language options and press Select to change to one of the following:
 - English (US) (*default*)
 - Français (French)
 - РУССКИЙ (Russian)
 - Español (Spanish)
 - Português (Portuguese)
 - Deutsch (German)
 - Italiano (Italian)
 - Polski (Polish)
 - Türkçe (Turkish)

Wireless Audio Module



WARNING

WM 10 is NOT waterproof.



NOTES

Charge your WM 10 before use by connecting the supplied USB cable to the battery charger.

The WM 10 Pairing LED may blink red occasionally when the WM 10 appears to be working correctly. This indicates a deterioration in radio communications and is for information only.

The WM 10 will not function if the control panel is fully submerged.

It is only necessary to perform the connection procedure once. After initial connection the detector and WM 10 will connect automatically.



WARNING

Once wireless is enabled and WM 10 is connected, all audio is expected to be generated by the WM 10 even if it is turned off. Disable wireless to return audio to the detector.

Wireless Audio Module

The Wireless Audio Module (WM 10) facilitates the use of wireless audio, using advanced WiStream technology to achieve clear sound with no perceivable time delay. It contains an internal loudspeaker and ¼" headphone socket for use with your choice of headphones. The WM 10 includes a rechargeable battery, which can be charged by the Li-Ion battery charger or a standard USB port. It can be used with a belt clip or simply dropped into your pocket.

The WM 10 operates on a single selectable RF channel in a global license-free location of the radio spectrum. The WM 10 has 14 channels, which allows multiple detectors to be used within the same vicinity without degraded performance.



Figure 35 – Wireless Audio Module (WM 10)

Connect the WM 10

To connect the WM 10 to your detector:

1. Press and hold the Power button on the WM 10 to turn it on.
2. Press and hold the Pairing button.
The Pairing LED will start blinking orange.
3. On the detector, highlight and select Options > Wireless Enable.
4. Highlight and select Wireless Connect.
5. Use the right and left arrow buttons to select a channel and press Select.

When Pairing is complete the LED will stop blinking and the WM 10 will emit a sound.

6. If Pairing fails, try selecting another channel.

The WM 10 provides some independent speaker/headphone volume controls, which when active, are configurable through the detector (page 22).

Use the Options menu on your detector to enable the Wireless function (page 48).

Minelab XChange 2



NOTES

When modifying settings via XChange 2, the modified settings are only 'applied' to the detector when the USB is removed. At this point, the detector checks for changes in the database and applies them. If you turn off the detector instead of unplugging the USB, these settings will not be applied correctly.

Refer to the Help menu in XChange 2 for more information on how to use the application to download, upload and modify your CTX 3030's settings.



XChange 2 Desktop Icon

Minelab XChange 2

Communicating between CTX 3030 and your PC

The CTX 3030 includes a USB connection facility (*page 2*). This allows you to connect your CTX 3030 to a Personal Computer (PC) and download/upload detector modes, GPS data, Discrimination Patterns and settings.

Using the XChange 2 application you can plot your GPS location data on Google Maps, add photos and comments, rename search modes and GPS data, and edit Discrimination Patterns.

System Requirements

- Windows 2000, Windows XP, Windows Vista or Windows 7
- Minimum recommended display resolution of 1366 x 768
- USB port

Install CTX 3030 XChange 2 on your PC

1. Insert the CD (included with your CTX 3030) into the CD/DVD drive of your PC.
2. The CD will auto-run once inserted into your PC and the Install program will start.
3. Follow the install prompts to install XChange 2 onto your PC.
4. Once you have installed XChange 2 on your PC you can start the application from either the Start menu or the shortcut on your desktop.

Start the CTX 3030 XChange 2 Application

Double click the XChange 2 application icon on your desktop, or open your Start Menu and navigate to: All Programs > Minelab > XChange 2.

Connect CTX 3030 to your PC

1. Insert one end of the USB cable into your CTX 3030 and the other end into your PC.
2. Start XChange 2 on your PC.
3. Although CTX 3030's transmitter is switched off while connected to a PC, make sure the coil is not located next to any large metal objects.
4. Turn on your CTX 3030.

A confirmation message will be displayed to indicate that the USB is connected. You can now use XChange 2. Refer to the XChange 2 User Manual supplied on the CD for further information.

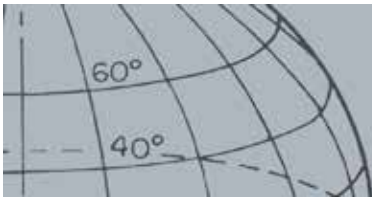

Factory Presets

Factory Presets

Modes

	Coins	Beach	Relics	Silver	High Trash
Pattern 1	New Coins	New Coins	Relics	New Silver	High Trash
Pattern 2	All but 1 Metal	All but 1 Metal	All Metal	All but 1 Metal	All but 1 Metal
Tone ID Profile	50 tone CO	50 tone CO	35 tone FE	50 tone CO	50 tone CO
Response	Normal	Normal	Smooth	Normal	Normal
Recovery Fast	Off	Off	On	Off	On
Recovery Deep	Off	On	On	Off	Off
Seawater	Off	Off	Off	Off	Off
Target Separation	High Trash	Low Trash	High Trash	High Trash	High Trash
Pinpoint	Normal	Normal	Normal	Normal	Sizing

Audio

	Detector Speaker	Detector Headphones	WM 10 Speaker	WM 10 Headphones	Global
Volume Gain					24
Threshold Level	30	30	30	30	
Volume Limit	30	15	30	15	
Threshold Pitch					15

Other Settings

Sensitivity Type	Auto
Auto Sensitivity Level	A
Manual Sensitivity Level	22
Ground Balance	Enable Off
Noise Cancel	Auto
GPS	Off



WARNING

Do not attempt to disassemble the Li-Ion battery pack.

If disposing of battery pack, do not incinerate. Contact your local authorities to enquire about disposal or recycling facilities.



NOTE

NiMH and NiCd have a lower voltage than alkaline batteries and therefore will never display a fully charged state.



NOTE

The detector regulates the output voltage so that its performance remains constant regardless of the charge remaining in the batteries.



NOTE

For best results, the battery pack must be recharged whenever the detector has been unused for a long period of time.

Batteries

The CTX 3030 standard pack is supplied with two types of battery pack:

1. A sealed rechargeable Lithium-Ion (Li-Ion) smart battery, which comes with a charger (BC 10) that plugs into a conventional wall socket and a car cigarette lighter socket. This battery pack is supplied partially charged and should be charged for up to two hours to maximise your first use. The detector will operate for up to 13 hours using the Li-Ion battery pack.
2. A replaceable cell pack, which accepts eight AA batteries including alkaline and rechargeable NiCd or NiMH batteries. The batteries are packed into a cell pack, which is inserted into the battery cover. The detector will operate for a minimum of seven hours using an alkaline battery pack

A battery icon displayed on the Control Panel (*Status Bar, page 5*) indicates the present charge level, and provides advanced warning of the need to recharge or replace the battery. The battery charge level is displayed in five segments, which will gradually decrease during operation relative to the voltage left in the battery. When the last segment disappears, the 'empty battery' icon will begin to flash and the battery low sound will emit every 20 seconds. If the detector is still operating at this time the voltage will drop to a point when a 'low battery' message will appear and the detector will turn itself off.

The Lithium-Ion battery pack provides more accurate remaining time on the battery indicator.

BC 10 Battery Charger

The BC 10 Battery Charger is supplied with your detector and is used to recharge the Li-Ion battery pack. The BC 10 operates from the AC plug pack (11 to 30 VDC), and from typical car (12 V) or truck systems (24 V). A USB connection is provided for charging the WM 10 (*page 53*).

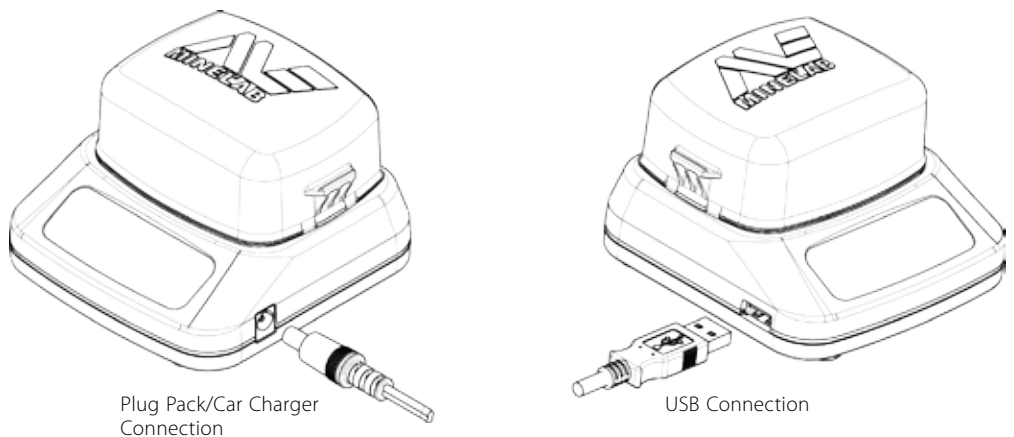

Figure 36 – BC 10 Plug pack and USB connections

Two bi-color LED indicators located on the front panel provide battery charge and power status information, summarized in Table 38.

Batteries



Figure 37 – BC 10 Front Panel

Battery LED		
	OFF	No battery plugged into charger
	Slow flashing green	Battery is charging, normal operation
	Fast flashing red	Charger error detected
	Steady on green	Battery is fully charged
Power LED		
	OFF	No input power, charger is OFF
	Steady on green	Correct input voltage, charger is ON, normal operation
	Fast flashing red	Incorrect input voltage, charger cannot operate

Table 38 – BC 10 battery charge and power status information

Recharge the Lithium-Ion Battery Pack

1. Remove the battery pack from the detector and place it into the charger unit, ensuring that the connector pins line up.

Batteries

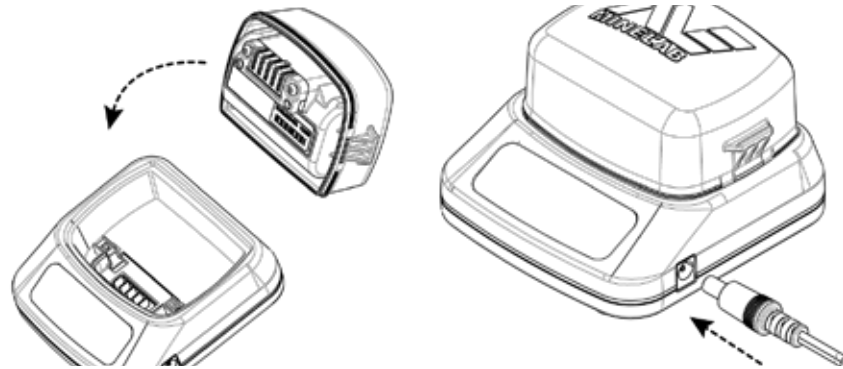

Figure 39 – Recharge the Li-Ion battery

2. Insert the plug pack or car charger cable connector into the socket on the right hand side of the charger unit.
3. Plug the other end of the cable into the wall or car socket and turn on the switch. Leave the unit to fully recharge.

The green indicator light will stop flashing and remain static when the battery is fully charged (*up to four hours*).

Replace the 'AA' Batteries

To replace the 'AA' batteries in the replaceable cell pack:

1. Open the pack by releasing the two side clips and removing the lid.
2. Place 8 x 'AA' cell alkaline batteries into the cell pack ensuring that the + and – terminals are aligned as indicated.
3. Replace the lid and push down until it 'clicks' into place.
4. Insert the cell pack into to the battery cover and push the pack onto the control box ensuring that the connector pins line up. Fasten the control box latches.

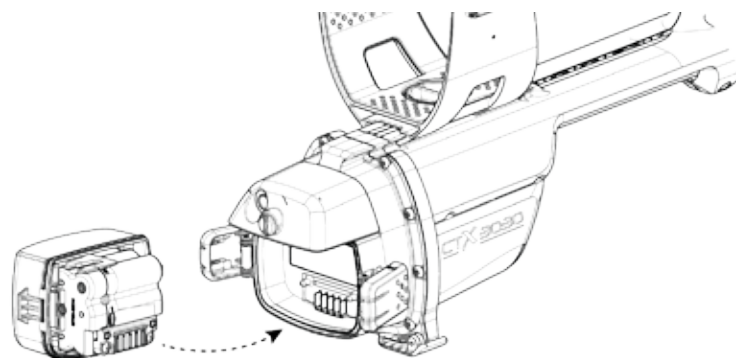

Figure 40 – Replace the AA batteries

High quality alkaline batteries are recommended for optimum detection time. Rechargeable alkaline, NiMH or NiCd batteries may be used but must be removed and recharged separately.



Batteries

Battery Care and Safety

To extend battery life:

- Use headphones; the speaker uses more power than headphones
- Turn off the backlight; the backlight increases the power consumption by approximately 8%
- Turn the detector off when not in use
- Turn GPS off when not in use
- Turn Wireless off when not in use



WARNING

Please note the following:

The Lithium-Ion battery is specifically designed for the CTX 3030. Attempting to use the Lithium-Ion battery pack with other detectors may damage the detector or the battery pack.

VERY IMPORTANT: Ensure the battery seal (o-ring), the o-ring seating groove and the mating face of the battery are undamaged and kept clean of sand, grit and other contaminants. Securely connect the battery to the detector before submersing in water.

Do not try to adapt this battery to other models as it will very likely cause damage.

Do not charge the battery at temperatures above 113° F (45° C) or below 32° F (0° C).

Do not immerse the battery pack in any liquid or allow water ingress. Battery packs are not waterproof until connected to the detector.

Ensure both the battery pack and control box are completely dry before connection.

Remove the battery pack from the detector during air travel or long term storage.

Do not immerse the BC 10 charger in any liquid or allow water ingress.

Do not leave the battery in hot conditions (e.g. on the dashboard or rear parcel shelf of your car).

Do not damage the battery in any way.

Do not short-circuit the battery.

Do not use the battery if it is damaged or deformed.

Do not disassemble or reconstruct the battery.

Do not incinerate the battery.

In the event of a fault, return the battery to a Minelab authorised service centre for repair. The use of unapproved components will VOID YOUR WARRANTY. There are no user serviceable parts within this battery pack.

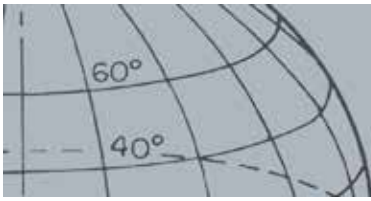

Accessories

Accessories

Parts and accessories available for CTX 3030:

- USB Cable - Detector to PC
- Lower Shaft
- Armrest and Stand Kit
- WM 10 with Belt Clip
- Coil (CTX 06) - 6" Round Double-D
- Coil (CTX 11) - 11" Round Double-D
- Coil (CTX 17) - 17" x 13" Elliptical Double-D Coil
- Coil Nuts, Bolts and Washers Kit
- Skidplate - 6" Round Double-D
- Skidplate - 11" Round Double-D
- Skidplate - 17" x 13" Elliptical Double-D Coil
- Battery Charger BC 10 Station
- Battery Charger Cable Kit
- Battery Holder for Replaceable Cells
- Battery Pack - Li-Ion Rechargeable
- Headphone Module
- Headphones
- Waterproof Headphones

If you would like to purchase any accessories for your CTX 3030 or any other Minelab product, please feel free to contact us directly or via your local Authorized Minelab dealer.

Detector Care and Safety

The CTX 3030 is a high-quality electronic instrument, finely engineered and packaged in a durable housing. Taking proper care of your detector is vital to ensure its ongoing reliability.



WARNING

Please note the following:

Not all parts of the CTX 3030 are waterproof.

Minelab recommends that prior to submersing in water, care is taken to ensure the battery seal (o-ring), the seal seating groove and the mating face of the battery are undamaged and kept clean. To achieve this, we recommend:

- Remove the battery seal with a soft tool
- Gently brush or wipe out the battery seal groove and battery mating face avoiding damage to the surfaces
- Wipe over the battery seal using a clean, moistened cloth
- Visually inspect the areas to ensure all sand, grit or other contaminants have been removed
- Refit the battery seal ensuring that it is seated at the bottom of the groove, is not twisted, and the corners are aligned
- Fit the battery to the detector.
- Ensure the battery clips are fully closed
- Damaged seals or batteries must be replaced prior to submersing your detector.

O-ring lubricant or grease is not required on waterproof seals.

Do not use a petroleum based o-ring grease as it is likely to damage the waterproof seals.

Do not leave the alkaline battery pack in the CTX 3030 when the detector is not in use for extended periods. Damage caused by leaking batteries could be severe and would void the warranty.

Do not leave the detector in excessive cold or heat longer than necessary. Covering it when not in use will help protect it. Avoid leaving it in a closed car trunk or in a car exposed to sunlight.

Never allow the detector to come into contact with gasoline or other petroleum-based liquids.

Avoid getting sand and grit into the shafts or fastenings (e.g. yoke bolt and cam lock). Do not use solvents to clean the detector. Use a damp cloth with mild soap detergent. Wash connectors with distilled water.

Hose the detector with clean water after use on the beach (wading or submersion).

If, through extensive use, the carbon-fiber upper or lower shafts become noticeably scored, wipe these thoroughly with a damp cloth.

Ensure the coil cable is in good condition and not subject to undue stress.

Flat or faulty batteries cause detector problems. Ensure that only quality alkaline batteries are used, and that they are replaced when you hear the warning signal through the headphones or speaker.

Do not dispose of the battery pack in fire (contact local authorities for disposal/recycling). Do not attempt to disassemble or short circuit the battery pack.

Take precautions when transporting or storing the detector. Although the detector is constructed from the highest quality materials and has undergone rigorous durability tests, the display screen could be prone to scratching or serious damage if not treated with due care.



GPS Status Bar Icon

GPS and Navigation

GPS

The Global Positioning System (GPS) is a space-based satellite navigation system that provides location and time information from any location where there is an unobstructed line of sight to four or more GPS satellites.

On the CTX 3030, GPS provides the capability to store location data relating to FindPoints and WayPoints, and to record GeoHunts. By default GPS is turned off and must be turned on through the Options menu (*page 48*).

Once GPS is enabled it may take some time for the GPS receiver to establish a valid position fix. Generally it will take less than five minutes, but may take up to fifteen. During this time, the GPS icon on the Status Bar will flash on and off. Once a valid position fix is established the GPS icon will remain static. You can use the GeoStore menu to record and store FindPoints, WayPoints and GeoHunts, and view them on the Map screen.



North Marker

Map

The Map screen allows you to view FindPoints, WayPoints, GeoHunts and GeoTrails in their relative geographic locations. The map displays north-south and east-west grid lines, centered on your current location. The upper horizontal edge of the map display will always represent north irrespective of the detector orientation, as indicated by the North Marker at the top right of the screen.

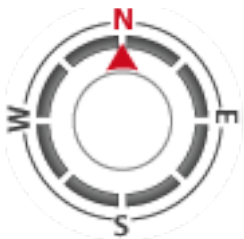

Navigation Tool

Navigation

The Navigation Tool allows you to navigate to a WayPoint, FindPoint or the start or end point of a GeoHunt.

With the Navigation Tool on, select an object to be navigated to from the GeoStore (*page 44*) and a Destination icon will appear on the Map or Detect screens. The Navigation Tool will help you navigate by displaying the distance and direction to your destination.



Destination Icon

The Destination icon will only appear when the Navigation Tool is turned on (*either on map screen or detect screen*). To turn off the Destination icon you need to turn off the Navigation Tool.

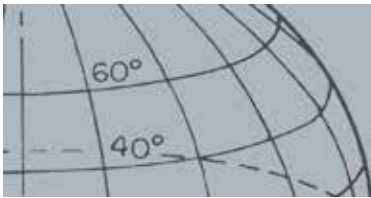

Detecting Basics

Detecting Basics

Holding the Detector



Figure 41 – Holding the detector

Thread your arm through the armrest and strap. Grasp the handle of the detector and rest your forearm in the armrest.

The correct position of the armrest should allow you to comfortably grip the handle. Your elbow should sit just above the back of the armrest and the detector should feel like an extension of your forearm.

Adjust the Length of the Shafts

The lower shaft can be adjusted to any length between fully extended and fully retracted. Adjust the lower shaft to the correct length and secure the cam lock to hold it in place.

A correct shaft length will allow you to swing the coil over the ground without uncomfortably stretching or stooping. If the coil is too far from your body it will be difficult to balance and manoeuvre while detecting. If the coil is too close to your body it may detect your digging tools or any other metal which you are carrying, causing confusing sounds.

Adjust the Angle of the Coil

1. Loosen the bolt that connects the lower shaft to the coil. It should be loose enough to allow the coil to be moved for adjustment, but tight enough that the coil can hold its position.
2. While holding the detector as if detecting, lightly press the coil to the ground until it sits flat/parallel with the ground. The coil should remain parallel when lifting to the sweep height, approximately one inch (25 mm) above the ground.
3. Tighten the bolt just enough to hold its position.



CAUTION

Sweeping the coil incorrectly can miss targets or generate false signals.

Sweeping the Coil

You will obtain the best performance when the coil is swept close and parallel to the ground at all times. This will increase detection depth and improve the response to small objects. Avoid excessive brushing of the coil on the ground.

Detecting Basics

Though the coil assembly is rigid and durable, sudden jolts or bangs can cause random signals and inaccurate target IDs, as well as excessive wear and tear. Careful sweeping will ensure the coil performs to an optimum level at all times.

Practice sweeping the coil over the ground in a side-to-side motion while slowly walking forward at the end of each sweep. Slightly overlap the previous sweep to ensure full ground coverage. An average sweep speed is four seconds from left to right to left.



NOTE

If you are getting signals from a visibly clear patch of ground, there could be buried metal objects. Try finding another area to practice.

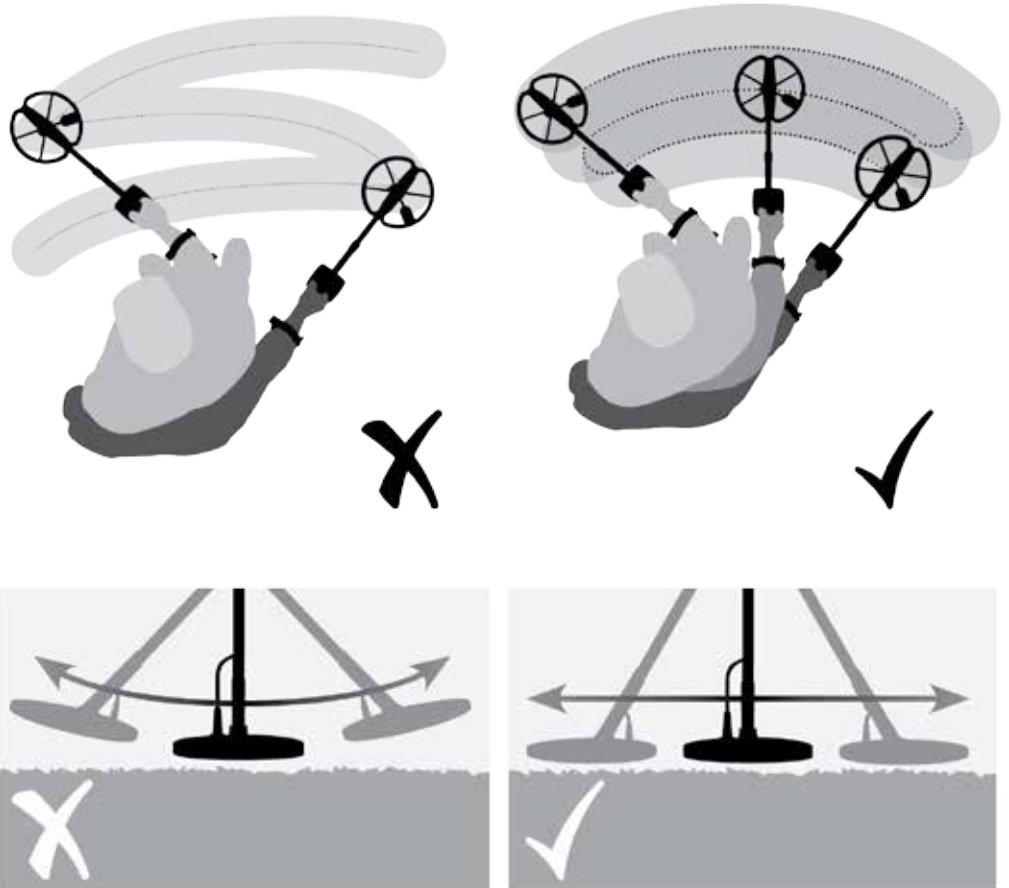

Figure 42 – Sweeping the coil

Targets

Metal objects are referred to as targets. Targets are comprised of ferrous and nonferrous metals. Ferrous metals are those containing iron; such as steel, nails and some types of coins. Nonferrous metals are those which are not magnetic, such as gold, silver, copper, bronze and aluminum.

You may wish to find a range of both ferrous and nonferrous targets.

Examples of common targets:

- Desired high ferrous target – war relic
- Undesired high ferrous target – iron nail
- Desired nonferrous target – gold coin
- Undesired nonferrous target – pull-tab

Detecting Basics

Detector Sounds

Turn the detector on. The constant background 'hum' produced by the detector is called the Threshold (*page 23*). Variations in the Threshold allow you to hear very small and deep targets. It is also used to help distinguish between desired and undesired targets.

The detector may also produce false signals (Noise) when not over the ground or with the coil held motionless. These may not be target signals, but surrounding electromagnetic interference (EMI). You can minimize false signals by performing a Noise Cancel (*page 20*), performing a Ground Balance (*page 22*), or by reducing the Sensitivity (*page 21*) of the detector. It is generally better to try to reduce false signals by adjusting Noise Cancel and Ground Balance before resorting to reducing the Sensitivity.

Sweep the coil across the targets one at a time. Observe the Detect screen and listen to the sounds of the detector as it passes over each object. The Detect screen and audio response will give you detailed information about the Target ID.

An audio signal is the sound produced by the detector when a target is detected and not 'rejected'. Large targets or targets close to the ground surface emit louder signals.

When a 'rejected' target is detected, the Threshold 'blanks' (becomes silent), indicating that a target is located underneath the coil, but has been rejected by the Discrimination Pattern (*Figure 43*). Blanking is a useful way of distinguishing between desired and undesired targets.

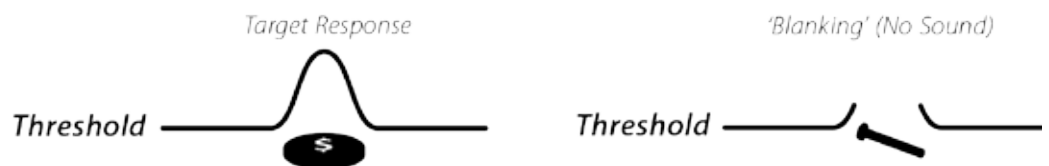

Figure 43 – Detector sounds

Very large objects close to the coil may overload the detector electronics. When this happens, the detector displays an overload message and emits a fading sound, which repeats until the coil is moved away from the source of the overload. Overloading is not harmful to the electronics of the detector.

It is best to operate the detector only when outdoors and away from sources of electromagnetic interference (EMI) such as power lines and phone towers. These sources may cause the detector to perform erratically, giving false signals and causing inaccurate target ID. There are also many metallic objects inside a house, such as nails in the floor, reinforcing in the walls, televisions and other household appliances, that might interfere with or overload the electronics of the detector.

It is important to understand the sounds produced when you make a valid or invalid button press. You will usually encounter these sounds while adjusting settings via the main menu. A valid button press makes a 'bip' sound; an invalid button press makes a 'ba-dump' sound.

Each time you turn the detector on, the last detection screen used before shutting down will appear. For example, if the CTX 3030 was operating in the Detect screen when turned off, this screen will appear when the detector is turned back on.

Simple Detecting Exercise

Simple Detecting Exercise

Before attempting to recover real targets, it is important to understand how to interpret the audio and visual signals of the detector.

1. Gather a collection of different metal objects, e.g. various coins, gold and silver jewelry, a nail, pull-tab, brass button and aluminum foil.
2. Take the detector outdoors, away from known sources of electromagnetic interferences (EMI) and metal objects.
3. Lay objects in a line, sufficiently spaced apart to allow the coil to pass between them, as shown in Figure 44.



NOTE

As the coil passes over the nail, the Threshold 'hum' momentarily disappears (blanks).



Figure 44 – Simple detecting exercise

Technical Specifications

Technical Specifications

CTX 3030



WARNING

Any changes or modifications not expressly approved by Minelab Electronics Pty Ltd could void the user's authority to operate this equipment.

Transmission	Full Band Spectrum 2 (FBS 2)
Simultaneous Frequency	Transmission ranging from 1.5–100 kHz
Coil	11" Double-D - Standard (accessory coils available)
Audio Output	Internal Speaker, Headphones, WiStream Wireless Audio
Liquid Crystal Display (LCD)	Full color, 320 x 240 pixels, 2.83" x 2.12" (72 mm x 54 mm)
GPS Engine	u-blox Neo-6
FindPoints	Up to 100 (FP001 – FP100)
WayPoints	Up to 100 (WP001 – WP100)
GeoHunts	Up to 10 (GH001 – GH010)
Length	Collapsed: 36.77" (934 mm) Laid flat, packed position: 40.66" (1033 mm) Extended: 55.15" (1401 mm) Laid flat, packed position: 59.05" (1500 mm)
Detector Weight	5.2 lb (2.36 kg) (with Li-Ion battery installed)
Coil Weight (including Skid plate)	1.4 lb (641 g)
Operating Temperature Range	32°F to 113°F (0°C to 45°C)
Operating Humidity Range	Up to 95% non-condensing
Storage Temperature Range	23°F to 150°F (-5°C to 70°C)
Storage Humidity Range	Up to 98% Relative Humidity
Operating Time (Li-Ion Battery)	13 hours (GPS, backlight, speaker enabled)

Table 45 – CTX 3030 Technical Specifications

Battery and Charger BC 10

Battery	
Type	Li-Ion Rechargeable Battery Pack or Replaceable 8 x AA
Output Voltage	Li-Ion: 7.2 V Nominal
Capacity	Li-Ion: 34 Wh
Charge Time	Up to 4 hours
Weight	Li-Ion pack: 0.56 lb (255 g)
Battery Operating Temperature	32°F to 113°F (0°C to 45°C)
Battery Storage Temperature	23°F to 176°F (-5°C to 70°C)
BC 10	
BC 10 Operating Temperature	32°F to 113°F (0°C to 45°C)
BC 10 Storage Temperature	-22°F to 176°F (-30°C to 80°C)
BC 10 Input Voltage	11 to 30 VDC
BC 10 USB Output Current	500 mA

Table 46 – CTX 3030 Li-Ion Battery Pack and Charger Specifications

Minelab Electronics Pty. Ltd

☎ +61 8 8238 0888
✉ minelab@minelab.com.au



Minelab International Ltd.

☎ +353 21 423 2352
✉ minelab@minelab.ie



Minelab MEA General Trading LLC

☎ +971 4 254 9995
✉ minelab@minelab.ae



Minelab Americas Inc.

☎ +1 630 401 8150
✉ info@minelabamericas.com



www.minelab.com